

Seals product range

Customized machined seals



ECONOMOS



Contents

The SKF brand now stands for more than ever before, and means more to you as a valued customer.

While SKF maintains its leadership as the hallmark of quality bearings throughout the world, new dimensions in technical advances, product support and services have evolved SKF into a truly solutions-oriented supplier, creating greater value for customers.

These solutions encompass ways to bring greater productivity to customers, not only with breakthrough application-specific products, but also through leading-edge design simulation tools and consultancy services, plant asset efficiency maintenance programmes, and the industry's most advanced supply management techniques.

The SKF brand still stands for the very best in rolling bearings, but it now stands for much more.

SKF – the knowledge engineering company

A Introduction

- 3 SKF Economos – your flexible partner
- 3 Seals
- 3 Advanced engineered plastics products
- 3 Other business and services

- 4 Sealing materials introduction
- 4 Classification of sealing materials

5 SKF Economos standard sealing materials

- 5 Polyurethanes
- 5 Hard grade polyurethanes
- 6 Elastomers
- 7 Special materials

8 Material data

B Product range seals

- 10 Piston seals
- 18 Rod seals
- 26 Wipers
- 32 Rotary seals
- 38 Guide rings
- 40 Back-up rings
- 43 Static seals

C Housing details

- 44 Piston seal housing details and recommendations

- 46 Rod seal housing details and recommendations

- 48 Wiper housing details and recommendations

- 50 Rotary seal housing details and recommendations

- 52 O-ring housing details and recommendations

- 53 Guide ring housing details and recommendations

- 54 SKF – the knowledge engineering company

SKF Economos – your flexible partner



SKF Economos is the leading player in the global custom-made machined seals market. Specialised in providing a complete sealing service to various industries, its subsidiaries and partners serve many countries around the world.

For its own subsidiaries, branch production sites and partner companies, SKF Economos develops turnkey CNC-controlled seal production units to enable local production of a wide range of seals. These manufacturing facilities are designed to provide truly local service being very close to the end customer.

Seals

With more than 20 years of experience SKF Economos is offering sealing solutions tailored to customer needs. With partnership from the design phase to serial production, SKF Economos is able to provide

- in-time manufacturing of seals and components up to 4 000 mm diameter
- more than 175 standard seals and tailor-made solutions
- unique production process from machining the single piece to moulding high quantities
- all seals in a wide range of materials covering tailor-made polyurethanes, standard and high performance elastomers as well as thermoplastics

Advanced engineered plastics products

SKF Economos is specialised in advanced engineered plastics products (AEPP). The offer goes from turned, milled and moulded parts to advanced and standard engineered plastic parts, using either in-house developed range of materials or materials from qualified suppliers.

Other business and services

SKF Economos also offers customers maintenance and repair of cylinders, gaskets and other products in miscellaneous materials by water-jet-cutting technology.

Furthermore, a wide range of semi-finished materials is available and material specialists can help customers to choose the best material for specific applications.



Sealing materials introduction

Due to increasing requirements within sealing technology, the importance of selecting the appropriate sealing material is emphasized.

Sealing materials are facing higher temperatures and pressures, higher sliding speeds and poorer lubricating fluids. The new generation of fluids like HFA and HFB fluids and biologically degradable hydraulic fluids (vegetable oils and synthetic esters) present new challenges to develop new sealing materials.

SKF Economos acknowledged this with the transfer of R&D from a standard solution provider to a developer of special, tailor-made solution. It became obvious that projects in close client co-operation succeeded best in achieving the optimal sealing solution.

SKF Economos has recognised all the advantages of Polyurethane in sealing technology. From our point of view, the superior characteristics of these materials have not yet been fully explored and leave scope for many other applications. In the future we expect a much stronger trend in this direction.

SKF Economos offers 15 standard materials that are featured in this brochure. All these materials have been developed by SKF Economos to meet standard customer needs. In addition, we supply special materials like SKF ECOFLAS, engineering thermoplastics

like SKF ECOTAL and high-temperature plastics, e.g. PPS, etc.

Classification of sealing materials

In sealing technology, mainly two groups of macromolecular (polymer) substances are used: elastomers and thermoplastics.

Macromolecular substances are organic compounds, its molecules consist of several thousands, often even millions of atoms, known as macro, giant, string or chain molecules. They can be created either by modification of highly molecular natural materials (e.g. natural rubber) or by depositing low-molecular elements (so called monomers) through various chemical reactions (synthetic materials, plastics).

Elastomers

Elastomers are materials that can be highly expanded by exerting relatively little power. Because of their structure, elastomers have a high retractibility, which means the compression set is very limited. There are two

main groups of elastomers; rubber materials and thermoplastic elastomers.

The rubber materials are polymers, which are formed by chemically cross-linked macromolecules with various vulcanization additives. Due to their chemical bonds they do not melt but rather begin to decompose at high temperatures. The cross-links also results in that the rubber materials don't dissolve or, depending on the medium, swell or shrink.

Thermoplastics

The Thermoplastic Elastomers demonstrate the characteristic properties of elastomers over a wide temperature range, but with the processing behaviour of thermoplastics. They can be melted at high temperature and can be processed with traditional thermoplastic processing techniques. Thermoplastic elastomers are soluble and they generally swell less in comparison to their chemically cross-linked equivalents.

Engineering Thermoplastics are e.g. SKF ECOTAL, SKF ECOMID, SKF ECOFLON and SKF ECOPAEK.

Thermoplastics can be melted. They are polymer materials, which are essentially harder and rigid at their application temperature compared to elastomers. Depending on the chemical structure, the properties vary from hard, to stiff, to ductile and flexible. Due to the morphological structure, extensive stretching is non-reversible and moulded parts remain in the deformed state. Thermoplastics are therefore called Plastomers.

Engineering Thermoplastics are applied in the sealing technology for back-up rings and guide rings, bearing bushes, etc.



SKF Economos standard sealing materials

Polyurethanes

ECOPUR (TPU) green

ECOPUR is a thermoplastic polyurethane elastomer, with an excellent abrasion resistance, low compression set, high physical properties and tear strength. ECOPUR is mostly used for U-cup seals, lip seals, wipers and chevron packings, but it may also be used for dampers and other machined parts. Products made from this material can be used in mineral oil, in water up to 40 °C and in bio-degradable hydraulic oils like vegetable oils and synthetic esters up to 60 °C (in these hydraulic fluids it is better to use H-ECOPUR instead of ECOPUR). Depending on the seal design and the installation housing seals made of ECOPUR can be used up to 400 bar (for higher pressure anti-extrusion-rings are required).

H-ECOPUR (TPU) red

H-ECOPUR is a hydrolysis-resistant thermoplastic polyurethane elastomer. It combines the engineering properties of ECOPUR with a high resistance to hydrolysis (degradation in water) which is otherwise rare when it comes to polyurethane's. E.g. it is stable in water up to +90 °C and has an outstanding stability in mineral oil. Because of its resistance to hydrolysis H-ECOPUR can be used for water hydraulic and for applications in mining, tunnelling and manufacturing of presses. H-ECOPUR is particularly recommended for the use in pure and seawater, for HFA and HFB fluids and biologically degradable hydraulic fluids (vegetable oils and synthetic esters) and food articles. H-ECOPUR is in conformance with various food regulations and can be used for many food-, beverage- and healthcare applications.

G-ECOPUR (CPU) red

G-ECOPUR is a cast hydrolysis-resistant polyurethane elastomer with similar properties to H-ECOPUR especially regarding its chemical



stability. G-ECOPUR can be used in the same hydraulic fluids as H-ECOPUR. Generally, G-ECOPUR is used for seals with a diameter range from 600 mm up to 4 000 mm.

T-ECOPUR (TPU) blue

T-ECOPUR is a thermoplastic polyurethane elastomer, that has been developed for low temperature applications. The properties of T-ECOPUR are similar to those of ECOPUR, but the minimum service temperature is extended to -50 °C. For that reason T-ECOPUR should be used under severe climatic conditions and for applications in freezing plants.

S-ECOPUR (TPU) grey

The new polyurethane brand has been optimised in regard of the tribological characteristics (friction and wear), achieved by an addition of a synergetic combination of solid lubricants. This special material is therefore best suited for most severe applications in the water hydraulics as well as in the non-lubricated pneumatics.

Hard grade polyurethanes

X-ECOPUR (TPU) dark green

X-ECOPUR is a thermoplastic polyurethane elastomere developed by SKF Economos. The composition of the material provides outstanding friction and wear properties as well as high pressure resistance. Therefore the material is well suited for the use as a composite seal, for wipers working in heavy-duty applications as well as for engineered plastic parts that need high elasticity and superior resilience behaviour.

Due to the exceptional extrusion resistance seals made of this material are working at higher pressure levels and larger clearances than those made of standard polyurethanes and PTFE compounds.

XH-ECOPUR (TPU) dark red

Compared to the standard grade H-ECOPUR, XH-ECOPUR has a significantly higher hardness. The composition of the material based on special raw materials provides outstanding friction and wear characteristics as well as pressure resistance. This material exhibits an outstanding chemical and hydrolysis resistance for applications in mineral oil, biodegradable hydraulic fluids (HETG and HEES, etc.) and water based fluids (HFA and HFB).

XS-ECOPUR (TPU) dark grey

Compared to the S-ECOPUR standard material XS-ECOPUR has a higher hardness and therefore further improved sliding properties. XS-ECOPUR has a better extrusion resistance than the standard material and therefore sealing elements of this material can be used at higher pressures, assuming the same profiles are used. XS-ECOPUR should be used instead of X-ECOPUR and XH-ECOPUR under poor lubricated working conditions. The material can also withstand dry-running depending on the overall service conditions.

Elastomers

SKF ECORUBBER-1 (NBR) black

SKF ECORUBBER-1 is an elastomer based on acrylonitrile-butadiene rubber and is used for U-cup seals, chevron packings, special seals and various components. This material has good resistance to mineral oils and greases and HFA, HFB and HFC pressure fluids. However, the material is not resistant to glycol-based brake fluids, HFD fluids, aromatic fluids (such as benzene), esters, ketones and amines or concentrated acids and bases.

SKF ECORUBBER-H (HNBR) black

SKF ECORUBBER-H is a hydrogenated or saturated acrylonitrile-butadiene rubber, suitable for applications in aliphatic hydrocarbons like propane or butane and mineral oils and greases (for short times up to 170 °C) and for sulfonated crude oil. Furthermore, it can be used in many diluted acids and bases and salt solutions even at elevated temperatures and in glycol-water mixtures. SKF ECORUBBER-H is not compatible with fuels with high content of aromatic hydrocar-

bons (premium blend petrol), gasolines (petrol/alcohol blends) ketones, esters, ethers and chlorinated hydrocarbons like trichloroethylene and tetrachloroethylene.

SKF ECORUBBER-2 (FPM, FKM) brown

SKF ECORUBBER-2 is an elastomer based on fluororubber (VITON®) that can be used for U-rings, lip seals, chevron packings, wipers and special seals. Its outstanding properties are high resistance to heat, weathering, ozone and many other chemicals.

SKF ECORUBBER-2 is compatible with mineral oils and greases containing sulphur, HFD pressure fluids (nearly all phosphate esters and chlorinated hydrocarbons), crude oil and sour gas. SKF ECORUBBER-2 is not resistant to anhydrous ammonia, amines, ketones, esters, hot water and low molecular weight organic acids.

SKF ECORUBBER-3 (EPDM) black

SKF ECORUBBER-3 is an elastomer based on ethylene-propylene rubber and can be used for U-cup seals, lip seals and chevron packings. SKF ECORUBBER-3 has an outstanding resistance to hot water, steam, washing agents and polar organic solvents. SKF ECORUBBER-3 is not resistant to mineral oil and other unpolar media. Its resistance to weathering, ozone and ageing is good. When used in glycol-based brake fluids, national regulations have to be adhered to.

SKF ECOSIL (MVQ) reddish brown

SKF ECOSIL is a silicone rubber and can be used for O-rings, gaskets and special seals. Due to its poor mechanical properties compared to those of other rubber materials, SKF ECOSIL is mostly used for static applications. SKF ECOSIL is highly resistant to weathering, ozone and ageing. Thanks to the content of aromatic hydrocarbons the material is compatible with mineral oil.

SKF ECOFLAS (TFE/P) black

SKF ECOFLAS is a unique fluoroelastomer based upon an alternating copolymer of tetrafluoroethylene and propylene (TFE/P). This material is chemically related to fluororubber. Compared to fluoro rubber materials SKF ECOFLAS shows slightly higher tensile strength and a quite similar heat resistance. The resistance of SKF ECOFLAS to mineral oils

is not as high as SKF ECORUBBER-2, but better than the mineral oil resistance of SKF ECORUBBER-1 and SKF ECORUBBER-H. SKF ECOFLAS exhibits outstanding resistance to hot water and hot steam up to 230 °C. The resistance to sourgas and amines, brake fluids (based on glycol, mineral oil or silicon oil) and fire-resistant hydraulic fluids is excellent. SKF ECOFLAS shows in contrast to SKF ECORUBBER-2 a good radiation resistance.



SKF ECOFLON 1 (PTFE-virgin) white

SKF ECOFLON 1 is a thermoplastic on the basis of polytetrafluoroethylene that is used for back-up rings, chevron packings, O-rings, rotary seals and gaskets. SKF ECOFLON 1 has the widest application range of all sealing materials. SKF ECOFLON 1 has an outstanding chemical resistance and will only be attacked by molten alkali metals and elementary Fluorine at high temperatures. Using PTFE seals, it should be noted that creeping occurs at relative low loads (pressures). SKF ECOFLON 1 is suitable for the food industry.

SKF ECOFLON 2 (PTFE +25% glass fibre + 5% MoS₂) grey

SKF ECOFLON 2 has improved compression strength as well as improved sliding properties in comparison to SKF ECOFLON 1. The chemical resistance is similar to SKF ECOFLON 1.

SKF ECOFLON 3 (PTFE +40% bronze) bronze

SKF ECOFLON 3 exhibits improved compression strength sliding properties as well as an

improved thermal conductivity in comparison to SKF ECOFLON 1.

SKF ECOFLON 4 (PTFE +25% carbon) black

SKF ECOFLON 4 shows improved mechanical strength, stiffness and hardness as well as improved sliding properties in comparison to SKF ECOFLON 1.

SKF ECOFLON 5 (PTFE modified) white

SKF ECOFLON 5 exhibits improved wear and abrasion resistance in comparison to

SKF ECOFLON 1. The material is suitable for food and beverage application.

SKF ECOTAL (POM) black

SKF ECOTAL is a semi-crystalline polyacetal-copolymer which is used for anti-extrusion rings, guide ring bushes, scrapers and for precision-machined parts with tight tolerances. SKF ECOTAL is one of the most important engineering thermoplastics with good physical properties, low water absorption and good chemical resistance. SKF ECOTAL can be used

in mineral oils, in water-based fire-resistant hydraulic fluids (HFA, HFB and HFC fluids). Concentrated acids and bases will attack and destroy it.

SKF ECOMID (PA) black

SKF ECOMID is a cast polyamide with good sliding properties and is used for back-up rings, guide rings and bearing components instead of SKF ECOTAL for a diameter above 260 mm. SKF ECOMID can be used in mineral oils and water-based fire-resistant hydraulic fluids. When designing parts out of SKF ECOMID for an application in water or water-based fluids, the swelling of the mate-

rial (SKF ECOMID absorbs water up to eight weight percent) must be taken into consideration.

SKF ECOPAEEK (PEEK) cream

SKF ECOPAEEK is a polymer with high tensile strength, stiffness, high heat distortion temperature and good sliding and friction behaviour. As far as strength and stiffness are concerned, SKF ECOPAEEK exceeds most technical plastics especially at high temperatures.

SKF ECOTEX (polyester resin + polyester fabric + graphite filler) light orange

SKF ECOTEX is a compound based on a thermosetting polyester resin and reinforced with fabric inlays. Due to the addition of graphite the material shows very good characteristics in respect to the tribological requirements of bearing materials in gliding systems. SKF ECOTEX shows high compressive strength and outstanding friction and wear properties. Therefore it is very well suited for guide rings and bearing bushes. Due to the very low absorption of moisture, SKF ECOTEX is particularly suitable for use in water and media containing water (swelling in water <0,1 %).

SKF ECOWEAR 1000 (UHMW-PE) white

SKF ECOWEAR 1000 is a semi crystalline thermoplastic material based on Polyethylene with a molecular weight of about 4 500 000 g/mol. SKF ECOWEAR 1000 has a very low coefficient of friction, an excellent wear resistance and impact strength (also at low temperature up to -200 °C), and in comparison to SKF ECOFLON a very high creep resistance and is almost water repellent and exhibits no swelling.





The main applications for SKF ECOWEAR 1000 are in areas where the following properties are required:







- outstanding sliding properties
- wear- and dry running properties in case of bad lubricating and aqueous media

Special materials

Any thermoplastic with mineral-reinforced polyamides, high temperature plastics like Polyphenylsulfide, etc.. All standard materials can be modified by SKF Economos to achieve tailor-made and optimised sealing solutions.





Piston seals



 Linear moving
  Rotating
  Oscillating
  Spiral moving
  Static
 Grey symbols: please consult our technical department for application limitations.

App-lication	Profile	Description	Temperature		Speed max.	Pressure		Material
			min.	max.		bar (psi)	max.	
			°C		m/s			-
	K01-P	Hydraulic, single-acting Asymmetric piston seal for standard applications. Design provides stable fit in the housing, ultimate sealing effect over a wide temperature range. Prevents extensive drag pressure. Back-to-back arrangement with guide ring in between for double-acting pistons or to separate different fluids. K01-PE has same data like K01-P	-30	+110	0,5	400 (5 800)	ECOPUR	
			-20	+110	0,5	400 (5 800)	H-ECOPUR	
			-20	+110	0,7	400 (5 800)	S-ECOPUR	
			-50	+110	0,5	400 (5 800)	T-ECOPUR	
			-30	+110	0,5	400 (5 800)	G-ECOPUR	
	K01-R	Hydraulic, single-acting As profile K01-P, but more adaptation possibilities for diverse temperatures and media by selection of suitable seal material. K01-RE has same parameters and data like profile K01-R.	-30	+100	0,5	160 (2 300)	SKF ECORUBBER-1	
			-20	+200	0,5	160 (2 300)	SKF ECORUBBER-2	
			-50	+150	0,5	160 (2 300)	SKF ECORUBBER-3 ²⁾	
			-25	+150	0,5	160 (2 300)	SKF ECORUBBER-H	
			-60	+200	-	-	SKF ECOSIL	
			-10	+200	0,5	160 (2300)	SKF ECOFLAS	
	K02-P	Hydraulic, single-acting Asymmetric piston seal for standard applications as K01-P, but due to design with active back-up ring suitable for higher pressure range or larger extrusion gaps. K02-P for standard housing design.	-30	+100	0,5	700 (10 000)	ECOPUR	Seal
			-20	+100	0,5	700 (10 000)	H-ECOPUR	Back-up ring
			-20	+100	0,7	700 (10 000)	S-ECOPUR	SKF ECOTAL ¹⁾
			-40	+100	0,5	700 (10 000)	T-ECOPUR	SKF ECOTAL ¹⁾
			-30	+100	0,5	700 (10 000)	G-ECOPUR	SKF ECOTAL ¹⁾
	K02-PD	Hydraulic, single-acting Asymmetric piston seal for standard applications as K01-P, but due to design with active back-up ring suitable for larger extrusion gaps. K02-PD for small housing design.	-30	+100	0,5	700 (10 000)	ECOPUR	Seal
			-20	+100	0,5	700 (10 000)	H-ECOPUR	Back-up ring
			-20	+100	0,7	700 (10 000)	S-ECOPUR	SKF ECOTAL ¹⁾
			-40	+100	0,5	700 (10 000)	T-ECOPUR	SKF ECOTAL ¹⁾
			-30	+100	0,5	700 (10 000)	G-ECOPUR	SKF ECOTAL ¹⁾
	K02-R	Hydraulic, single-acting As profile K02-P, but more adaptation possibilities to diverse temperatures and media by selection of suitable seal material. K02-R for standard housing design.	-30	+100	0,5	250 (3 600)	SKF ECORUBBER-1	Seal
			-20	+200	0,5	250 (3 600)	SKF ECORUBBER-2	Back-up ring
			-50	+100	0,5	250 (3 600)	SKF ECORUBBER-3 ²⁾	SKF ECOTAL ¹⁾
			-50	+150	0,5	250 (3 600)	SKF ECORUBBER-3 ²⁾	SKF ECOFLON 2
			-25	+100	0,5	250 (3 600)	SKF ECORUBBER-H	SKF ECOTAL ¹⁾
			-25	+150	0,5	250 (3 600)	SKF ECORUBBER-H	SKF ECOFLON 2
			-10	+200	0,5	250 (3 600)	SKF ECOFLAS	SKF ECOPAЕК
	K02-RD	Hydraulic, single-acting As profile K02-P, but more adaptation possibilities to diverse temperatures and media by selection of suitable seal material. K02-RD for small housing design.	-30	+100	0,5	250 (3 600)	SKF ECORUBBER-1	Seal
			-20	+200	0,5	250 (3 600)	SKF ECORUBBER-2	Back-up ring
			-50	+100	0,5	250 (3 600)	SKF ECORUBBER-3 ²⁾	SKF ECOFLON 2
			-50	+150	0,5	250 (3 600)	SKF ECORUBBER-3 ²⁾	SKF ECOTAL ¹⁾
			-25	+100	0,5	250 (3 600)	SKF ECORUBBER-H	SKF ECOFLON 2
			-25	+150	0,5	250 (3 600)	SKF ECORUBBER-H	SKF ECOFLON 2
			-10	+200	0,5	250 (3 600)	SKF ECOFLAS	SKF ECOPAЕК

¹⁾ SKF ECOTAL up to Ø260 mm, SKF ECOMID above Ø260 mm
²⁾ ATTENTION: Not suitable for mineral oils!





Piston seals







 Linear moving
  Rotating
  Oscillating
  Spiral moving
  Static
 Grey symbols: please consult our technical department for application limitations.

App-lication	Profile	Description	Temperature		Speed max.	Pressure		Material		
			min.	max.		bar (psi)	max.	Seal	O-ring	
			°C		m/s			-	-	
	K03-P	Hydraulic, single-acting O-ring activated, asymmetrical piston seal. interference fit on inside diameter maintains stable fit in the housing. design provides ultimate sealing effect. Especially suitable for short stroke applications (e.g. spindle seals, coupling actuators..)	-30	+100	0,5	400 (5 800)	ECOPUR	Seal	O-ring	
			-20	+100	0,5	400 (5 800)	H-ECOPUR	NBR 70		
			-20	+100	0,7	400 (5 800)	S-ECOPUR	NBR 70		
			-50	+100	0,5	400 (5 800)	T-ECOPUR	NBR 70		
	K03-F	PTFE-piston seal, single-acting O-ring activated, asymmetrical PTFE piston seal, low friction and no stick-slip effect. Good adaptation possibilities for diverse temperatures and media by selection of suitable O-ring material, almost no dead spots as required for applications in food and pharma industry.	-30	+100	1	200 (2 900)	SKF ECOFLON 1	Seal	O-ring	
			-55	+200	1	200 (2 900)	SKF ECOFLON 1	NBR 70		
			-30	+100	1	400 (5 800)	SKF ECOFLON 2,3,4	NBR 70		
			-20	+200	1	400 (5 800)	SKF ECOFLON 2,3,4	FPM 75		
			-50	+150	1	400 (5 800)	SKF ECOFLON 2,3,4	EPDM		
			-55	+200	1	400 (5 800)	SKF ECOFLON 2,3,4	MVQ 70		
			-30	+80	0,5	200 (2 900)	SKF ECOWEAR1000	NBR 70		
			-55	+80	0,5	200 (2 900)	SKF ECOWEAR1000	MVQ 70		
	K03-S ²⁾	PTFE-piston seal, single-acting Helicoil spring activated, asymmetrical PTFE piston seal, low friction and no stick-slip effect, excellent chemical and thermal resistance, mainly used in chemical, pharma and food industry or for valves.	-200	+260	1	200 (2 900)	SKF ECOFLON 1	Seal	Spring	
			-200	+260	1	400 (5 800)	SKF ECOFLON 2,3,4	1,4310 ³⁾		
			-200	+80	0,5	200 (2 900)	SKF ECOWEAR1000	1,4310 ³⁾		
	K04-P	Hydraulic, single-acting Asymmetric piston seal for standard applications as K03-P, but due to design with active back-up ring suitable for larger extrusion gaps or higher pressure. K04-P for standard housing design	-30	+100	0,5	700 (10 000)	ECOPUR	Seal	Back-up ring	
			-20	+100	0,5	700 (10 000)	H-ECOPUR	SKF ECOTAL ¹⁾		
			-40	+100	0,5	700 (10 000)	T-ECOPUR	SKF ECOTAL ¹⁾		
			-20	+100	0,7	700 (10 000)	S-ECOPUR	SKF ECOTAL ¹⁾		
	K04-PD	Hydraulic, single-acting Asymmetric piston seal for standard applications as K03-P, but due to design with active back-up ring suitable for larger extrusion gaps. K04-PD for small housing design	-30	+100	0,5	700 (10 000)	ECOPUR	Seal	Back-up ring	
			-20	+100	0,5	700 (10 000)	H-ECOPUR	SKF ECOTAL ¹⁾		
			-40	+100	0,5	700 (10 000)	T-ECOPUR	SKF ECOTAL ¹⁾		
			-20	+100	0,7	700 (10 000)	S-ECOPUR	SKF ECOTAL ¹⁾		
	K05-P	Pneumatic, single-acting Asymmetric piston seal, extremely wear resistant, for use in lubricated or dry pneumatic applications. Special design of sealing lip allows retention of initial lubricating film.	-30	+110	1	25 (360)	ECOPUR	Seal		
			-20	+110	1	25 (360)	H-ECOPUR			
			-20	+110	2	25 (360)	S-ECOPUR			
			-50	+110	1	25 (360)	T-ECOPUR			
			-30	+110	1	25 (360)	G-ECOPUR			

¹⁾ SKF ECOTAL up to Ø260 mm, SKF ECOMID above Ø260 mm
²⁾ Upgrade profile
³⁾ Spring steel material definition





Piston seals





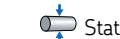

 Linear moving
  Rotating
  Oscillating
  Spiral moving
  Static
 Grey symbols: please consult our technical department for application limitations.

App-lication	Profile	Description	Temperature		Speed max.	Pressure		Material	
			min.	max.		max.	max.		
			°C		m/s	bar (psi)	-		
	K05-R	Pneumatic, single-acting Asymmetric piston seal, good wear resistant, for use in lubricated or dry pneumatic applications. Good adaptation possibilities for diverse temperatures and media by selection of suitable seal material. Special design of sealing lip allows retention of initial lubricating film.	-30	+100	1	25 (360)	SKF ECORUBBER-1		
			-20	+200	1	25 (360)	SKF ECORUBBER-2		
			-50	+150	1	25 (360)	SKF ECORUBBER-3 ³⁾		
			-25	+150	1	25 (360)	SKF ECORUBBER-H		
			-10	+200	1	25 (360)	SKF ECOFLAS		
	K06-P	Hydraulic, single-acting Symmetric piston seal for simple standard applications, not recommended for new designs (profile K01-P preferred). Also for larger cross section, easier to install.	-30	+110	0,5	400 (5 800)	ECOPUR		
			-20	+110	0,5	400 (5 800)	H-ECOPUR		
			-20	+110	0,7	400 (5 800)	S-ECOPUR		
			-50	+110	0,5	400 (5 800)	T-ECOPUR		
			-30	+110	0,5	400 (5 800)	G-ECOPUR		
	K06-R	Hydraulic, single-acting As profile K06-P, but more adaptation possibilities for diverse temperatures and media by selection of suitable seal material. Also for larger cross section, easier to install.	-30	+100	0,5	160 (2 300)	SKF ECORUBBER-1		
			-20	+200	0,5	160 (2 300)	SKF ECORUBBER-2		
			-50	+150	0,5	160 (2 300)	SKF ECORUBBER-3 ³⁾		
			-25	+150	0,5	160 (2 300)	SKF ECORUBBER-H		
			-10	+200	0,5	160 (2 300)	SKF ECOFLAS		
	K07-P	Hydraulic, single-acting O-ring activated symmetric piston seal for simple standard applications, not recommended for new designs (profile K03-P preferred)	-30	+100	0,5	400 (5 800)	ECOPUR	NBR 70	
			-20	+100	0,5	400 (5 800)	H-ECOPUR	NBR 70	
			-20	+100	0,7	400 (5 800)	S-ECOPUR	NBR 70	
			-50	+100	0,5	400 (5 800)	T-ECOPUR	MVQ 70	
	K08-E	Hydraulic, single-acting O-ring activated asymmetric PTFE piston seal, low friction. For extreme low or high speed. Suitable for positioning functions.	-30	+100	10	600 (8 700)	SKF ECOFLON 2,3,3F,4	NBR 70	
			-20	+200	10	600 (8 700)	SKF ECOFLON 2,3,3F,4	FPM/FKM 75	
			-30	+100	5	600 (8 700)	X-ECOPUR (X, XH, XS)	NBR 70	
			-55	+110	5	600 (8 700)	X-ECOPUR (X, XH, XS)	MVQ 70	
			-30	+80	5	400 (5 800)	SKF ECOWEAR 1000	NBR 70	
	K08-D ²⁾	Hydraulic, double acting O-ring activated symmetric PTFE piston seal, low friction. For extreme low or high speed, suitable for positioning functions. For mobile hydraulics, machine tools, injection moulding machines, heavy hydraulics.	-30	+100	10	600 (8 700)	SKF ECOFLON 2,3,3F,4	NBR 70	
			-20	+200	10	600 (8 700)	SKF ECOFLON 2,3,3F,4	FPM/FKM 75	
			-30	+100	5	600 (8 700)	X-ECOPUR (X, XH, XS)	NBR 70	
			-55	+110	5	600 (8 700)	X-ECOPUR (X, XH, XS)	MVQ 70	
			-30	+80	5	400 (5 800)	SKF ECOWEAR 1000	NBR 70	

¹⁾ SKF ECOTAL up to Ø260 mm, SKF ECOMID above Ø260 mm
²⁾ For standard dimensions list refer to X-SLIDE brochure nr. 18270
³⁾ ATTENTION: Not suitable for mineral oils!





Piston seals









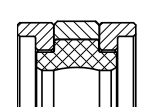

 Linear moving
  Rotating
  Oscillating
  Spiral moving
  Static
 Grey symbols: please consult our technical department for application limitations.

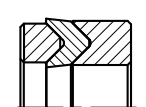
App-lication	Profile	Description	Temperature		Speed max.	Pressure		Material	
			min.	max.		max.	max.		
			°C		m/s	bar (psi)	-		
	K08-P	Hydraulic, double-acting O-ring activated symmetric PU piston seal with excellent static and dynamic sealing capacity, extremely wear resistant.	-30	+100	1	250 (3 600)	Glide ring	O-ring	
			-20	+100	1	250 (3 600)	ECOPUR	NBR 70	
			-20	+100	1,4	250 (3 600)	H-ECOPUR	NBR 70	
			-50	+100	1	250 (3 600)	S-ECOPUR	NBR 70	
	K08-ES	Hydraulic, single-acting Profile ring-activated asymmetric PTFE piston seal, similar to K08-E, but special heavy duty design. For heavy industry hydraulics or for special housing dimensions.	-30	+100	10	600 (8 700)	SKF ECOFLON 2,3,3F,4	SKF ECORUBBER-1	
			-20	+200	10	600 (8 700)	SKF ECOFLON 2,3,3F,4	SKF ECORUBBER-2	
			-30	+100	5	600 (8 700)	X-ECOPUR (X, XH, XS)	SKF ECORUBBER-1	
			-60	+100	5	600 (8 700)	X-ECOPUR (X, XH, XS)	SKF ECOSIL	
			-30	+80	5	400 (5 800)	SKF ECOWEAR 1000	SKF ECORUBBER-1	
	K08-DS ²⁾	Hydraulic, double-acting Profile ring-activated symmetric PTFE piston seal, similar to S09-D, but special heavy duty design. For heavy industry hydraulics or for special housing dimensions.	-30	+100	10	600 (8 700)	SKF ECOFLON 2,3,3F,4	SKF ECORUBBER-1	
			-20	+200	10	600 (8 700)	SKF ECOFLON 2,3,3F,4	SKF ECORUBBER-2	
			-30	+100	5	600 (8 700)	X-ECOPUR (X, XH, XS)	SKF ECORUBBER-1	
			-60	+100	5	600 (8 700)	X-ECOPUR (X, XH, XS)	SKF ECOSIL	
			-30	+80	5	400 (5 800)	SKF ECOWEAR 1000	SKF ECORUBBER-1	
	K09-N	Hydraulic, double-acting Profile ring-activated compact piston seal with integrated guiding elements. Excellent static sealing capacity. Commonly used in standard cylinders.	-30	+100	0,5	400 (5 800)	ECOPUR	Energizer	Back-up
			-20	+100	0,5	400 (5 800)	H-ECOPUR	SKF ECORUBBER-1	SKF ECOTAL ¹⁾
			-50	+100	0,5	400 (5 800)	T-ECOPUR	SKF ECOSIL	SKF ECOTAL ¹⁾
			-20	+100	0,7	400 (5 800)	S-ECOPUR	SKF ECORUBBER-1	SKF ECOTAL ¹⁾
	K09-D ³⁾	Hydraulic, double-acting Profile ring-activated compact piston seal with integrated guiding elements. Excellent static and dynamic sealing capacity.	-30	+100	0,5	400 (5 800)	ECOPUR	Energizer	Back-up
			-20	+100	0,5	400 (5 800)	H-ECOPUR	SKF ECORUBBER-1	SKF ECOTAL ¹⁾
			-50	+100	0,5	400 (5 800)	T-ECOPUR	SKF ECOSIL	SKF ECOTAL ¹⁾
			-20	+100	0,7	400 (5 800)	S-ECOPUR	SKF ECORUBBER-1	SKF ECOTAL ¹⁾
	K09-H ³⁾	Hydraulic, double-acting Profile ring-activated compact piston seal with integrated guiding elements. Design for high pressure range, excellent static sealing capacity. Mainly used in mining / tunneling industry.	-30	+100	0,3	1500 (21700)	ECOPUR	Energizer	Back-up
			-20	+100	0,3	1500 (21700)	H-ECOPUR	SKF ECORUBBER-1	SKF ECOTAL ¹⁾
			-50	+100	0,3	1500 (21700)	T-ECOPUR	SKF ECOSIL	SKF ECOTAL ¹⁾
			-20	+100	0,4	1500 (21700)	S-ECOPUR	SKF ECORUBBER-1	SKF ECOTAL ¹⁾

¹⁾ SKF ECOTAL up to Ø260 mm, SKF ECOMID above Ø260 mm
²⁾ For standard dimensions list refer to X-SLIDE brochure nr. 18270
³⁾ Upgrade profile



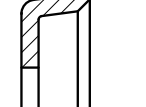

Piston seals









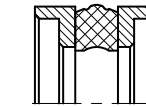

 Linear moving
  Rotating
  Oscillating
  Spiral moving
  Static
 Grey symbols: please consult our technical department for application limitations.

App-lication	Profile	Description	Temperature		Speed max.	Pressure max.	Material		
			min.	max.			Seal	Energizer	Back-up ring
			°C		m/s	bar (psi)	-		
 	K09-F ²⁾	Hydraulic, double-acting Profile ring-activated compact PTFE piston seal with integrated guiding elements. Low friction, good chemical and thermal resistance.	-30	+100	1,5	400 (5 800)	Seal	Energizer	Back-up ring
			-20	+200	1,5	400 (5 800)	SKF ECOFLON 2,3,4	SKF ECORUBBER-1	SKF ECOTAL
			-30	+100	1	400 (5 800)	SKF ECOFLON 2,3,4	SKF ECORUBBER-2	SKF ECOPAEK
			-30	+100	1	400 (5 800)	X-ECOPUR	SKF ECORUBBER-1	SKF ECOTAL
			-30	+100	1,2	400 (5 800)	XH-ECOPUR	SKF ECORUBBER-1	SKF ECOTAL
						XS-ECOPUR	SKF ECORUBBER-1	SKF ECOTAL	
 	K1012-T	Hydraulic, single-acting Chevron sealing set, machined surface design. In back-to-back arrangement with one intermediate chevron for double sided pressure activation, in single-acting applications with more intermediate chevrons possible. for heavy industry hydraulics.	-30	+100	0,5	500 (7 200)	K 10-A	K 11-T	K 12-T
			-20	+100	0,5	500 (7 200)	SKF ECOTAL ¹⁾	ECOPUR	X-ECOPUR
			-20	+100	0,5	500 (7 200)	SKF ECOTAL ¹⁾	H-ECOPUR	XH-ECOPUR
			-20	+100	0,5	500 (7 200)	SKF ECOTAL ¹⁾	S-ECOPUR	XS-ECOPUR
			-30	+100	0,7	500 (7 200)	SKF ECOTAL ¹⁾	G-ECOPUR	G-ECOPUR 54D ³⁾
			-30	+100	0,5	250 (3 600)	SKF ECOFLON 2	SKF ECORUBBER-1	SKF ECOFLON 2
			-20	+200	0,5	250 (3 600)	SKF ECOFLON 2	SKF ECORUBBER-2	SKF ECOFLON 2
			-50	+150	0,5	250 (3 600)	SKF ECOFLON 2	SKF ECORUBBER-3	SKF ECOFLON 2
			-25	+150	0,5	250 (3 600)	SKF ECOFLON 2	SKF ECORUBBER-H	SKF ECOFLON 2
 	K1012-M	Hydraulic, single-acting Chevron sealing set, parted surface design. In back-to-back arrangement with one intermediate chevron for double sided pressure activation, in single-acting applications with more intermediate chevrons possible. for heavy industry hydraulics.	-30	+100	0,5	500 (7 200)	K 10-A	K 11-M	K 12-M
			-20	+100	0,5	500 (7 200)	SKF ECOTAL ¹⁾	ECOPUR	X-ECOPUR
			-20	+100	0,5	500 (7 200)	SKF ECOTAL ¹⁾	H-ECOPUR	XH-ECOPUR
			-20	+100	0,5	500 (7 200)	SKF ECOTAL ¹⁾	S-ECOPUR	XS-ECOPUR
			-30	+100	0,7	500 (7 200)	SKF ECOTAL ¹⁾	G-ECOPUR	G-ECOPUR 54D ³⁾
			-30	+100	0,5	250 (3 600)	SKF ECOFLON 2	SKF ECORUBBER-1	SKF ECOFLON 2
			-20	+200	0,5	250 (3 600)	SKF ECOFLON 2	SKF ECORUBBER-2	SKF ECOFLON 2
			-50	+150	0,5	250 (3 600)	SKF ECOFLON 2	SKF ECORUBBER-3	SKF ECOFLON 2
			-25	+150	0,5	250 (3 600)	SKF ECOFLON 2	SKF ECORUBBER-H	SKF ECOFLON 2
 	K1315-T	Hydraulic, single-acting Chevron sealing set, design with flexible sealing lips, good sealing ability in higher pressure range. For heavy industry hydraulics, water-hydraulic systems	-30	+100	0,5	600 (8 700)	K 13-T	K 14-T	K 15-T
			-20	+100	0,5	600 (8 700)	SKF ECOTAL ¹⁾	ECOPUR	X-ECOPUR
			-20	+100	0,7	600 (8 700)	SKF ECOTAL ¹⁾	H-ECOPUR	XH-ECOPUR
			-20	+100	0,7	600 (8 700)	SKF ECOTAL ¹⁾	S-ECOPUR	XS-ECOPUR
			-30	+100	0,5	600 (8 700)	SKF ECOTAL ¹⁾	ECOPUR	SKF ECOTAL
			-20	+100	0,5	600 (8 700)	SKF ECOTAL ¹⁾	H-ECOPUR	SKF ECOTAL
			-40	+100	0,5	600 (8 700)	SKF ECOTAL ¹⁾	T-ECOPUR	SKF ECOTAL
			-20	+100	0,7	600 (8 700)	SKF ECOTAL ¹⁾	S-ECOPUR	SKF ECOTAL
			-30	+100	0,5	600 (8 700)	SKF ECOTAL ¹⁾	G-ECOPUR	SKF ECOTAL or ³⁾
 	K16-A	Hydraulic/pneumatic, single-acting Simple cup seal, usually fixed on the piston by means of a clamping plate. Mainly used for replacement in old hydraulic and pneumatic cylinders or for low-grade secondary applications. Also used for food filling / portioning equipment.	-30	+110	0,5	160 (2 300)	ECOPUR/G-ECOPUR		
			-20	+110	0,5	160 (2 300)	H-ECOPUR		
			-50	+110	0,5	160 (2 300)	T-ECOPUR		
			-20	+110	0,7	160 (2 300)	S-ECOPUR		
			-30	+100	0,5	160 (2 300)	SKF ECORUBBER-1		
			-25	+150	0,5	160 (2 300)	SKF ECORUBBER-H		
			-20	+200	0,5	160 (2 300)	SKF ECORUBBER-2		
			-50	+150	0,5	160 (2 300)	SKF ECORUBBER-3		
			-10	+200	0,5	160 (2 300)	SKF ECOFLAS		
 	K16-B	Hydraulic/pneumatic, single-acting Simple cup seal, usually fixed on the piston by means of a clamping plate. Mainly used for replacement in old hydraulic and pneumatic cylinders or for low-grade secondary applications. Also used for food filling / portioning equipment.	-30	+110	0,5	160 (2 300)	ECOPUR/G-ECOPUR		
			-20	+110	0,5	160 (2 300)	H-ECOPUR		
			-50	+110	0,5	160 (2 300)	T-ECOPUR		
			-20	+110	0,7	160 (2 300)	S-ECOPUR		
			-30	+100	0,5	160 (2 300)	SKF ECORUBBER-1		
			-25	+150	0,5	160 (2 300)	SKF ECORUBBER-H		
			-20	+200	0,5	160 (2 300)	SKF ECORUBBER-2		
			-50	+150	0,5	160 (2 300)	SKF ECORUBBER-3		
			-10	+200	0,5	160 (2 300)	SKF ECOFLAS		

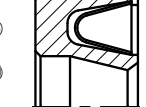
¹⁾ SKF ECOTAL up to Ø260 mm, SKF ECOMID above Ø260 mm
²⁾ Upgrade profile
³⁾ Hard grade G-ECOPUR (54 ShoreD)

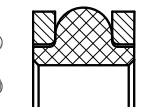

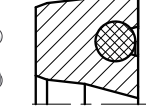

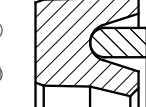
Piston seals

 Linear moving
  Rotating
  Oscillating
  Spiral moving
  Static
 Grey symbols: please consult our technical department for application limitations.































App-lication	Profile	Description	Temperature		Speed max.	Pressure max.	Material	
			min.	max.			Seal	Back-up ring
			°C		m/s	bar (psi)	-	
 	K17-P	Hydraulic, double-acting Space saving, compact piston seal with integrated guiding elements. Excellent static sealing capacity, suitable for small housings.	-30	+100	0,5	250 (3 600)	Seal	Back-up ring
			-20	+100	0,5	250 (3 600)	ECOPUR	SKF ECOTAL ¹⁾
			-40	+100	0,5	250 (3 600)	H-ECOPUR	SKF ECOTAL ¹⁾
			-20	+100	0,7	250 (3 600)	T-ECOPUR	SKF ECOTAL ¹⁾
							S-ECOPUR	SKF ECOTAL ¹⁾
 	K17-R	Hydraulic, double-acting Space saving, compact piston seal with integrated guiding elements. Excellent static sealing capacity, good adaptation possibilities for diverse temperatures and media by selection of suitable material. Suitable for small housings.	-30	+100	0,5	250 (3 600)	Seal	Back-up ring
			-25	+100	0,5	250 (3 600)	SKF ECORUBBER-1	SKF ECOTAL ¹⁾
			-25	+150	0,5	250 (3 600)	SKF ECORUBBER-H	SKF ECOTAL ¹⁾
			-25	+150	0,5	250 (3 600)	SKF ECORUBBER-H	SKF ECOFLON 2
			-25	+150	0,5	250 (3 600)	SKF ECORUBBER-H	SKF ECOPAEK
			-20	+200	0,5	250 (3 600)	SKF ECORUBBER-2	SKF ECOFLON 2
			-20	+200	0,5	250 (3 600)	SKF ECORUBBER-2	SKF ECOPAEK
 	K19-F	PTFE piston seal, single-acting Finger-spring activated, asymmetrical PTFE piston seal, low friction and good dry running properties, excellent chemical and thermal resistance, mainly used in chemical, pharma and food industry.	-200	+260	15	200 (2 900)	Seal	Spring
			-200	+260	15	400 (5 800)	SKF ECOFLON 1	1.4310 ²⁾
			-200	+260	15	400 (5 800)	SKF ECOFLON 2	1.4310 ²⁾
			-200	+260	15	400 (5 800)	SKF ECOFLON 3	1.4310 ²⁾
			-200	+260	15	400 (5 800)	SKF ECOFLON 4	1.4310 ²⁾
 	K20-R	Hydraulic, double-acting Space saving, compact piston seal, suitable for standard O-Ring housings. Advantage compared to O-Ring: integrated active back-up rings for high pressure, design with interference fit on outside diameter prevents twisting in dynamic applications.	-30	+100	0,5	700 (10.000)	Seal	Back-up ring
			-25	+100	0,5	700 (10.000)	SKF ECORUBBER-1	SKF ECOTAL ¹⁾
			-25	+150	0,5	700 (10.000)	SKF ECORUBBER-H	SKF ECOTAL ¹⁾
			-25	+150	0,5	700 (10.000)	SKF ECORUBBER-H	SKF ECOFLON 2
			-25	+150	0,5	700 (10.000)	SKF ECORUBBER-H	SKF ECOPAEK
			-20	+200	0,5	700 (10.000)	SKF ECORUBBER-2	SKF ECOPAEK
			-20	+200	0,5	700 (10.000)	SKF ECORUBBER-2	SKF ECOFLON 2
 	K21-P	Hydraulic, single-acting O-Ring activated symmetric piston seal with sharp-edged sealing lips, good sealing effect for high viscosity fluids, not recommended for new designs (Profile S03-P preferred).	-30	+100	0,5	400 (5 800)	Seal	O-ring
			-20	+100	0,5	400 (5 800)	ECOPUR	NBR 70
			-50	+100	0,5	400 (5 800)	H-ECOPUR	NBR 70
			-20	+100	0,7	400 (5 800)	T-ECOPUR	MVQ 70
							S-ECOPUR	NBR 70
 	K22-P	Hydraulic, single-acting Symmetric piston seal with support ring for simple applications to serve repair purpose, not recommended for new designs (Profile K01-P preferred). Retainer ring in angled design possible.	-30	+100	0,5	400 (5 800)	Seal	Support ring
			-20	+100	0,5	400 (5 800)	ECOPUR	SKF ECOTAL ¹⁾
			-40	+100	0,5	400 (5 800)	H-ECOPUR	SKF ECOTAL ¹⁾
			-20	+100	0,7	400 (5 800)	T-ECOPUR	SKF ECOTAL ¹⁾
							S-ECOPUR	SKF ECOTAL ¹⁾

¹⁾ SKF ECOTAL up to Ø260 mm, SKF ECOMID above Ø260 mm
²⁾ Spring steel material definition

Piston seals





 Linear moving
  Rotating
  Oscillating
  Spiral moving
  Static

Grey symbols: please consult our technical department for application limitations.











App- lication	Profile	Description	Temperature		Speed max.	Pressure max.	Material		
			min.	max.			Seal	Support rings	
			°C		m/s	bar (psi)	-		
    	K22-R	Hydraulic, single-acting Symmetric piston seal as K22-P, but more adaptation possibilities for diverse temperatures and media by selection of suitable seal material. Retainer (support) ring in angled design possible.	-30	+100	0,5	160 (2 300)	Seal SKF ECORUBBER-1 SKF ECORUBBER-2 SKF ECORUBBER-3 ²⁾ SKF ECORUBBER-3 ²⁾ SKF ECORUBBER-H SKF ECORUBBER-H SKF ECOFLAS	Support rings SKF ECOTAL ¹⁾ SKF ECOFLON 2 SKF ECOTAL ¹⁾ SKF ECOFLON 2 SKF ECOTAL ¹⁾ SKF ECOFLON 2 SKF ECOFLON	
			-20	+200					
			-50	+100					
			-50	+150					
			-25	+100					
-25	+150								
-10	+200								
    	K23-N ³⁾	Hydraulic, double-acting Profile ring-activated compact piston seal with integrated back-up rings, excellent static sealing capacity. External guiding elements required.	-30	+100	0,5	400 (5 800)	Seal ECOPUR H-ECOPUR T-ECOPUR S-ECOPUR	Energizer SKF ECORUBBER-1 SKF ECORUBBER-1 SKF ECOSIL SKF ECORUBBER-1	Back-up rings SKF ECOTAL ¹⁾ SKF ECOTAL ¹⁾ SKF ECOTAL ¹⁾ SKF ECOTAL ¹⁾ SKF ECOTAL ¹⁾
			-20	+100					
			-40	+100					
			-20	+100					
			-20	+100					
    	K23-D	Hydraulic, double-acting Profile ring-activated compact piston seal with integrated back-up rings. Excellent static and dynamic sealing capacity. External guiding elements required.	-30	+100	0,5	400 (5 800)	Seal ECOPUR H-ECOPUR T-ECOPUR S-ECOPUR	Energizer SKF ECORUBBER-1 SKF ECORUBBER-1 SKF ECOSIL SKF ECORUBBER-1	Back-up rings SKF ECOTAL ¹⁾ SKF ECOTAL ¹⁾ SKF ECOTAL ¹⁾ SKF ECOTAL ¹⁾
			-20	+100					
			-40	+100					
			-20	+100					
			-20	+100					
    	K23-H	Hydraulic, double-acting Profile ring-activated compact piston seal with integrated back-up rings. Design for high pressure range, excellent static sealing capacity. Mainly used in mining / tunneling industry. External guiding elements required.	-30	+100	0,3	1 500 (21 000)	Seal ECOPUR H-ECOPUR T-ECOPUR S-ECOPUR	Energizer SKF ECORUBBER-1 SKF ECORUBBER-1 SKF ECOSIL SKF ECORUBBER-1	Back-up rings SKF ECOTAL ¹⁾ SKF ECOTAL ¹⁾ SKF ECOTAL ¹⁾ SKF ECOTAL ¹⁾
			-20	+100					
			-50	+100					
			-30	+100					
			-20	+100					
    	K23-F	Hydraulic, double-acting Profile ring-activated compact PTFE piston seal with integrated back-up rings. Low friction, good chemical and thermal resistance. External guiding elements required.	-30	+100	1,5	400 (5 800)	Seal SKF ECOFLON 2,3,4 SKF ECOFLON 2,3,4 X-ECOPUR XH-ECOPUR XS-ECOPUR	Energizer SKF ECORUBBER-1 SKF ECORUBBER-2 SKF ECORUBBER-1 SKF ECORUBBER-1 SKF ECORUBBER-1	Back-up rings SKF ECOTAL ¹⁾ SKF ECOPA EK SKF ECOTAL ¹⁾ SKF ECOTAL ¹⁾ SKF ECOTAL ¹⁾
			-20	+200					
			-30	+100					
			-30	+100					
			-30	+100					
    	K24-P	Hydraulic, single-acting Chevron ring with flexible lip design. Replacement part for standard commercial housings (male and female adapter mainly made of metal).	-30	+110	0,5	500 (7 200)	Seal ECOPUR/G-ECOPUR H-ECOPUR T-ECOPUR S-ECOPUR SKF ECORUBBER-1 SKF ECORUBBER-2 SKF ECORUBBER-3 ²⁾ SKF ECORUBBER-H SKF ECOFLAS		
			-20	+110					
			-50	+110					
			-20	+110					
			-30	+100					

¹⁾ SKF ECOTAL up to Ø260 mm, SKF ECOMID above Ø260 mm
²⁾ ATTENTION: Not suitable for mineral oils!
³⁾ Upgrade profile

Piston seals

 Linear moving
  Rotating
  Oscillating
  Spiral moving
  Static





Grey symbols: please consult our technical department for application limitations.



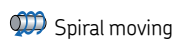

App- lication	Profile	Description	Temperature		Speed max.	Pressure max.	Material		
			min.	max.			Pressure rings	Seal	Support rings
			°C		m/s	bar (psi)	-		
    	K32-P ²⁾	Hydraulic, single-acting Chevron sealing set, design with extremely flexible sealing lips for difficult operating conditions like bad guiding, large tolerance range. Available as total chevron sealing set as well as intermediate chevrons only (in case of metal male and female adapters).	-30	+100	0,5	500 (7 200)	Pressure rings SKF ECOTAL ¹⁾ SKF ECOTAL ¹⁾ SKF ECOTAL ¹⁾ SKF ECOTAL ¹⁾ SKF ECOTAL ¹⁾ X-ECOPUR XH-ECOPUR XS-ECOPUR G-ECOPUR 54D	Seal ECOPUR ³⁾ H-ECOPUR T-ECOPUR S-ECOPUR ECOPUR H-ECOPUR S-ECOPUR G-ECOPUR	Support rings SKF ECOTAL ¹⁾ SKF ECOTAL ¹⁾ SKF ECOTAL ¹⁾ SKF ECOTAL ¹⁾ SKF ECOTAL ¹⁾ SKF ECOTAL ¹⁾ SKF ECOTAL ¹⁾ SKF ECOTAL ¹⁾ SKF ECOTAL ¹⁾
			-20	+100					
			-40	+100					
			-20	+100					
			-30	+100					
    	K35-P ²⁾	Hydraulic, double-acting Compact piston seal with almost no dead spots as required for applications in food and pharma industry, also commonly used as O-Ring replacement, because design with interference fit on outside diameter maintains non-twisting in dynamic applications.	-30	+110	0,4	400 (5 800)	Seal ECOPUR H-ECOPUR T-ECOPUR S-ECOPUR G-ECOPUR		
			-20	+110					
			-50	+110					
			-20	+110					
			-30	+110					

¹⁾ SKF ECOTAL up to Ø260 mm, SKF ECOMID above Ø260 mm
²⁾ Upgrade profile
³⁾ or G-ECOPUR

B



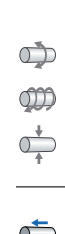
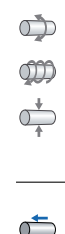

Rod seals



 Linear moving
  Rotating
  Oscillating
  Spiral moving
  Static
 Grey symbols: please consult our technical department for application limitations.

App- lication	Profile	Description	Temperature		Speed max.	Pressure max.	Material	
			min.	max.				
			°C		m/s	bar (psi)	-	
	S01-P	Hydraulic, single-acting Asymmetric rod seal for standard applications. Interference fit on outside diameter maintains stable fit in the housing. Design provides ultimate sealing effect over a wide temperature range and good backpumping ability. Also used as secondary seal in combination with PTFE seal type S09.	-30	+110	0,5	400 (5 800)	ECOPUR	
			-20	+110	0,5	400 (5 800)	H-ECOPUR	
			-20	+110	0,7	400 (5 800)	S-ECOPUR	
			-50	+110	0,5	400 (5 800)	T-ECOPUR	
			-30	+110	0,5	400 (5 800)	G-ECOPUR	
	S01-R	Hydraulic, single-acting As profile S01-P, but more adaptation possibilities for diverse temperatures and media by selection of suitable seal material.	-30	+100	0,5	160 (2 300)	SKF ECORUBBER-1	
			-20	+200	0,5	160 (2 300)	SKF ECORUBBER-2	
			-50	+150	0,5	160 (2 300)	SKF ECORUBBER-3 ²⁾	
			-25	+150	0,5	160 (2 300)	SKF ECORUBBER-H	
			-60	+200	-	-	SKF ECOSIL	
			-10	+200	0,5	160 (2 300)	SKF ECOFLAS	
			-	-	-	-	-	
	S02-P	Hydraulic, single-acting Asymmetric rod seal for standard applications as S01-P, but due to design with active back-up ring suitable for larger extrusion gaps or higher pressure range. S02-P for standard housing design	-30	+100	0,5	700 (10 000)	Seal ECOPUR	Back-up ring SKF ECOTAL ¹⁾
			-20	+100	0,5	700 (10 000)	H-ECOPUR	SKF ECOTAL ¹⁾
			-20	+100	0,7	700 (10 000)	S-ECOPUR	SKF ECOTAL ¹⁾
			-40	+100	0,5	700 (10 000)	T-ECOPUR	SKF ECOTAL ¹⁾
			-30	+100	0,5	700 (10 000)	G-ECOPUR	SKF ECOTAL ¹⁾
			-	-	-	-	-	-
	S02-PD	Hydraulic, single-acting Asymmetric rod seal for standard applications as S01-P, but due to design with active back-up ring suitable for larger extrusion gaps or higher pressure range. S02-PD for small housing design	-30	+100	0,5	700 (10 000)	Seal ECOPUR	Back-up ring SKF ECOTAL ¹⁾
			-20	+100	0,5	700 (10 000)	H-ECOPUR	SKF ECOTAL ¹⁾
			-20	+100	0,7	700 (10 000)	S-ECOPUR	SKF ECOTAL ¹⁾
			-40	+100	0,5	700 (10 000)	T-ECOPUR	SKF ECOTAL ¹⁾
			-30	+100	0,5	700 (10 000)	G-ECOPUR	SKF ECOTAL ¹⁾
			-	-	-	-	-	-
	S02-R	Hydraulic, single-acting as profile S02-P, but more adaptation possibilities for diverse temperatures and media by selection of suitable seal material. S02-R for standard housing design	-30	+100	0,5	250 (3 600)	Seal SKF ECORUBBER-1	Back-up ring SKF ECOTAL ¹⁾
			-20	+200	0,5	250 (3 600)	SKF ECORUBBER-2	SKF ECOFLON 2
			-50	+100	0,5	250 (3 600)	SKF ECORUBBER-3 ²⁾	SKF ECOTAL ¹⁾
			-50	+150	0,5	250 (3 600)	SKF ECORUBBER-3 ²⁾	SKF ECOFLON 2
			-25	+100	0,5	250 (3 600)	SKF ECORUBBER-H	SKF ECOTAL ¹⁾
			-25	+150	0,5	250 (3 600)	SKF ECORUBBER-H	SKF ECOFLON 2
			-10	+200	0,5	250 (3 600)	SKF ECOFLAS	SKF ECOPAEK
			-	-	-	-	-	-
	S02-RD	Hydraulic, single-acting As profile S02-P, but more adaptation possibilities for diverse temperatures and media by selection of suitable seal material. S02-RD for small housing design	-30	+100	0,5	250 (3 600)	Seal SKF ECORUBBER-1	Back-up ring SKF ECOTAL ¹⁾
			-20	+200	0,5	250 (3 600)	SKF ECORUBBER-2	SKF ECOFLON 2
			-50	+100	0,5	250 (3 600)	SKF ECORUBBER-3 ²⁾	SKF ECOTAL ¹⁾
			-50	+150	0,5	250 (3 600)	SKF ECORUBBER-3 ²⁾	SKF ECOFLON 2
			-25	+100	0,5	250 (3 600)	SKF ECORUBBER-H	SKF ECOTAL ¹⁾
			-25	+150	0,5	250 (3 600)	SKF ECORUBBER-H	SKF ECOFLON 2
			-10	+200	0,5	250 (3 600)	SKF ECOFLAS	SKF ECOPAEK

¹⁾ SKF ECOTAL up to Ø260 mm, SKF ECOMID above Ø260 mm
²⁾ ATTENTION: Not suitable for mineral oils!



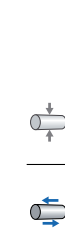
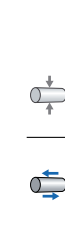
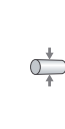

Rod seals

 Linear moving
  Rotating
  Oscillating
  Spiral moving
  Static
 Grey symbols: please consult our technical department for application limitations.



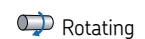



App- lication	Profile	Description	Temperature		Speed max.	Pressure max.	Material		
			min.	max.					
			°C		m/s	bar (psi)	-		
	S02-S ²⁾	Hydraulic, single-acting Asymmetric rod seal, for special housings (DIN/ISO 7425 part 2) and for the use as a primary rod seal in sealing systems, due to design with active back-up ring suitable for high pressure peaks or larger extrusion gaps.	-30	+100	5	400 (5 800)	Seal ECOPUR	Back-up ring SKF ECOTAL ¹⁾	
			-20	+100	5	400 (5 800)	H-ECOPUR	SKF ECOTAL ¹⁾	
			-40	+100	5	400 (5 800)	T-ECOPUR	SKF ECOTAL ¹⁾	
			-20	+100	7	400 (5 800)	S-ECOPUR	SKF ECOTAL ¹⁾	
			-	-	-	-	-	-	
	S03-P	Hydraulic, single-acting O-Ring activated, asymmetrical rod seal. Interference fit on outside diameter maintains stable fit in the housing. Design provides ultimate sealing effect, especially suitable for short stroke applications (e.g. spindle seals, coupling actuators...)	-30	+100	0,5	400 (5 800)	Seal ECOPUR	O-ring NBR 70	
			-20	+100	0,5	400 (5 800)	H-ECOPUR	NBR 70	
			-50	+100	0,5	400 (5 800)	T-ECOPUR	MVQ 70	
			-20	+100	0,7	400 (5 800)	S-ECOPUR	NBR 70	
			-30	+100	0,5	400 (5 800)	G-ECOPUR	NBR 70	
			-	-	-	-	-	-	
			-	-	-	-	-	-	
	S03-F	PTFE rod seal, single-acting O-Ring activated, asymmetrical PTFE rod seal, low friction, good dry running properties and adaptation possibilities for diverse temperatures and media by selection of suitable O-Ring material, almost no dead spots as required for applications in food & pharma industry.	-30	+100	1	200 (2 900)	Seal SKF ECOFLON 1	O-ring NBR 70	
			-55	+200	1	200 (2 900)	SKF ECOFLON 1	MVQ 70	
			-30	+100	1	400 (5 800)	SKF ECOFLON 2,3,4	NBR 70	
			-20	+200	1	400 (5 800)	SKF ECOFLON 2,3,4	FPM 75	
			-50	+150	1	400 (5 800)	SKF ECOFLON 2,3,4	EPDM	
			-55	+200	1	400 (5 800)	SKF ECOFLON 2,3,4	MVQ 70	
			-30	+80	0,5	200 (2 900)	SKF ECOWEAR1000	NBR 70	
			-55	+80	0,5	200 (2 900)	SKF ECOWEAR1000	MVQ 70	
			-	-	-	-	-	-	
			-	-	-	-	-	-	
	S03-S ²⁾	PTFE rod seal, single-acting Helicoil spring activated, asymmetrical PTFE rod seal, low friction and good dry running properties, excellent chemical and thermal resistance, mainly used in chemical, pharma and food industry.	-200	+260	1	200 (2 900)	Seal SKF ECOFLON 1	Spring 1.4310	
			-200	+260	1	400 (5 800)	SKF ECOFLON 2,3,4	1.4310	
			-200	+80	0,5	200 (2 900)	SKF ECOWEAR1000	1.4310	
			-	-	-	-	-	-	
	S04-P	Hydraulic, single-acting Asymmetric rod seal for standard applications as S03-P, but due to design with active back-up ring suitable for larger extrusion gaps or higher pressure range. S04-P for standard housing design.	-30	+100	0,5	700 (10 000)	Seal ECOPUR	O-ring NBR 70	Back-up SKF ECOTAL ¹⁾
			-20	+100	0,5	700 (10 000)	H-ECOPUR	NBR 70	SKF ECOTAL ¹⁾
			-40	+100	0,5	700 (10 000)	T-ECOPUR	MVQ 70	SKF ECOTAL ¹⁾
			-20	+100	0,7	700 (10 000)	S-ECOPUR	NBR 70	SKF ECOTAL ¹⁾
			-	-	-	-	-	-	
	S04-PD	Hydraulic, single-acting Asymmetric rod seal for standard applications as S03-P, but due to design with active back-up ring suitable for larger extrusion gaps or higher pressure range. S04-PD for small housing design.	-30	+100	0,5	700 (10 000)	Seal ECOPUR	O-ring NBR 70	Back-up SKF ECOTAL ¹⁾
			-20	+100	0,5	700 (10 000)	H-ECOPUR	NBR 70	SKF ECOTAL ¹⁾
			-40	+100	0,5	700 (10 000)	T-ECOPUR	MVQ 70	SKF ECOTAL ¹⁾
			-20	+100	0,7	700 (10 000)	S-ECOPUR	NBR 70	SKF ECOTAL ¹⁾
			-	-	-	-	-	-	

¹⁾ SKF ECOTAL up to Ø260 mm, SKF ECOMID above Ø260 mm
²⁾ Upgrade profile

Rod seals





 Linear moving
  Rotating
  Oscillating
  Spiral moving
  Static

Grey symbols: please consult our technical department for application limitations.







App- lication	Profile	Description	Temperature		Speed max.	Pressure		Material		
			min.	max.		max.	max.		°C	m/s
	S05-P	Pneumatic, single-acting Asymmetric rod seal, extremely wear resistant, for use in lubricated or dry pneumatic applications. Special design of sealing lip allows retention of initial lubricating film.	-30	+110	1	25 (360)	ECOPUR			
			-20	+110	1	25 (360)	H-ECOPUR			
			-20	+110	2	25 (360)	S-ECOPUR			
			-50	+110	1	25 (360)	T-ECOPUR			
			-30	+110	1	25 (360)	G-ECOPUR			
	S05-R	Pneumatic, single-acting As profile S05-R, good wear resistance and adaptation possibilities for diverse temperatures and media by selection of suitable seal material. special design of sealing lip allows retention of initial lubricating film.	-30	+100	1	25 (360)	SKF ECORUBBER-1			
			-20	+200	1	25 (360)	SKF ECORUBBER-2			
			-50	+150	1	25 (360)	SKF ECORUBBER-3 ¹⁾			
			-25	+150	1	25 (360)	SKF ECORUBBER-H			
			-10	+200	1	25 (360)	SKF ECOFLAS			
	S06-P	Hydraulic, single-acting Symmetric rod seal for simple standard applications, not recommended for new designs (profile S01-P should be preferred).	-30	+110	0,5	400 (5 800)	ECOPUR			
			-20	+110	0,5	400 (5 800)	H-ECOPUR			
			-20	+110	0,7	400 (5 800)	S-ECOPUR			
			-50	+110	0,5	400 (5 800)	T-ECOPUR			
			-30	+110	0,5	400 (5 800)	G-ECOPUR			
	S06-R	Hydraulic, single-acting As profile S06-P, but more adaptation possibilities for diverse temperatures and media by selection of suitable seal material.	-30	+100	0,5	160 (2 300)	SKF ECORUBBER-1			
			-20	+200	0,5	160 (2 300)	SKF ECORUBBER-2			
			-50	+150	0,5	160 (2 300)	SKF ECORUBBER-3 ¹⁾			
			-25	+150	0,5	160 (2 300)	SKF ECORUBBER-H			
			-60	+200	–	–	SKF ECOSIL			
			-10	+200	0,5	160 (2 300)	SKF ECOFLAS			
	S07-P	Hydraulic, single-acting O-ring activated symmetric rod seal for simple standard applications, not recommended for new designs (profile S03-P preferred)	-30	+100	0,5	400 (5 800)	ECOPUR	Seal	O-ring	
			-20	+100	0,5	400 (5 800)	H-ECOPUR	ECOPUR	NBR 70	
			-20	+100	0,7	400 (5 800)	S-ECOPUR	NBR 70	NBR 70	
			-50	+100	0,5	400 (5 800)	T-ECOPUR	MVQ 70	MVQ 70	
			Profile S07-F has similar parameters and data like profile S03-F.							
	S08-P	Hydraulic, single-acting Asymmetric compact rod seal with stable fit in the housing. Compact design mainly used to seal high viscosity fluids or for extreme small housings, not suitable for high speed applications. S08-P compact design, no groove	-30	+110	0,3	400 (5 800)	ECOPUR			
			-20	+110	0,3	400 (5 800)	H-ECOPUR			
			-20	+110	0,4	400 (5 800)	S-ECOPUR			
			-50	+110	0,3	400 (5 800)	T-ECOPUR			

¹⁾ ATTENTION: Not suitable for mineral oils!

Rod seals

 Linear moving
  Rotating
  Oscillating
  Spiral moving
  Static





Grey symbols: please consult our technical department for application limitations.







App- lication	Profile	Description	Temperature		Speed max.	Pressure		Material		
			min.	max.		max.	max.		°C	m/s
	S08-PE	Hydraulic, single-acting Asymmetric compact rod seal with stable fit in the housing. Compact design mainly used to seal high viscosity fluids or for extreme small housings, not suitable for high speed applications. S08-PE with small groove.	-30	+110	0,3	400 (5 800)	ECOPUR			
			-20	+110	0,3	400 (5 800)	H-ECOPUR			
			-20	+110	0,4	400 (5 800)	S-ECOPUR			
			-50	+110	0,3	400 (5 800)	T-ECOPUR			
			-30	+100	0,5	400 (5 800)	G-ECOPUR			
	S08-R	Hydraulic, single-acting As profile S08-P, but more adaptation possibilities for diverse temperatures and media by selection of suitable seal material.	-30	+100	0,3	160 (2 300)	SKF ECORUBBER-1			
			-20	+200	0,3	160 (2 300)	SKF ECORUBBER-2			
			-50	+150	0,3	160 (2 300)	SKF ECORUBBER-3 ¹⁾			
			-25	+150	0,3	160 (2 300)	SKF ECORUBBER-H			
			-10	+200	0,3	160 (2 300)	SKF ECOFLAS			
	S09-E ²⁾	Hydraulic, single-acting O-ring activated asymmetric PTFE rod seal, low friction. In tandem design together with double-acting wipers for extreme low or high speed or positioning functions. As primary seal in combination with secondary S01-P seal with good resistance to pressure shocks used in mobile hydraulics, machine tools, injection moulding machines, heavy hydraulics.	-30	+100	10	600 (8 700)	SKF ECOFLON 2,3,3F,4	Glide ring	O-ring	
			-20	+200	10	600 (8 700)	SKF ECOFLON 2,3,3F,4	NBR 70	NBR 70	
			-30	+100	5	600 (8 700)	X-ECOPUR (X, XH, XS)	FPM/FKM 75	NBR 70	
			-55	+110	5	600 (8 700)	X-ECOPUR (X, XH, XS)	NBR 70	NBR 70	
			-30	+80	5	400 (5 800)	ECOWEAR 1000	MVQ 70	NBR 70	
			-55	+80	5	400 (5 800)	ECOWEAR 1000	MVQ 70	MVQ 70	
	S09-D	Hydraulic, double-acting O-ring activated symmetric PTFE rod seal, low friction. For extreme low or high speed, suitable for positioning functions.	-30	+100	10	600 (8 700)	SKF ECOFLON 2,3,3F,4	Glide ring	O-ring	
			-20	+200	10	600 (8 700)	SKF ECOFLON 2,3,3F,4	NBR 70	NBR 70	
			-30	+100	5	600 (8 700)	X-ECOPUR (X, XH, XS)	FPM/FKM 75	NBR 70	
			-55	+110	5	600 (8 700)	X-ECOPUR (X, XH, XS)	NBR 70	NBR 70	
			-30	+80	5	400 (5 800)	ECOWEAR 1000	MVQ 70	NBR 70	
			-55	+80	5	400 (5 800)	ECOWEAR 1000	MVQ 70	MVQ 70	
	S09-P	Hydraulic, single-acting O-ring activated asymmetric PU rod seal with excellent dynamic sealing capacity. Used as secondary seal in tandem design (together with primary S09-E) to minimize residual oil film. For mobile hydraulics, injection moulding machines, heavy hydraulics.	-30	+100	1	250 (3 600)	ECOPUR	Glide ring	O-ring	
			-20	+100	1	250 (3 600)	H-ECOPUR	NBR 70	NBR 70	
			-50	+110	1	250 (3 600)	T-ECOPUR	NBR 70	NBR 70	
			-20	+100	1,4	250 (3 600)	S-ECOPUR	MVQ 70	NBR 70	
			-30	+100	1	250 (3 600)	G-ECOPUR	NBR 70	NBR 70	
	S09-ES ²⁾	Hydraulic, single-acting Profile ring-activated asymmetric PTFE rod seal, similar to S09-E, but special heavy duty design for heavy industry hydraulics or for special housing dimensions.	-30	+100	10	600 (8 700)	SKF ECOFLON 2,3,3F,4	Glide ring	Energizer	
			-20	+200	10	600 (8 700)	SKF ECOFLON 2,3,3F,4	NBR 70	NBR 70	
			-30	+100	5	600 (8 700)	X-ECOPUR (X, XH, XS)	SKF ECORUBBER-1	SKF ECORUBBER-1	
			-60	+110	5	600 (8 700)	X-ECOPUR (X, XH, XS)	SKF ECOSIL	SKF ECOSIL	
			-30	+80	5	400 (5 800)	ECOWEAR 1000	SKF ECORUBBER-1	SKF ECORUBBER-1	
			-60	+80	5	400 (5 800)	ECOWEAR 1000	SKF ECOSIL	SKF ECOSIL	

¹⁾ ATTENTION: Not suitable for mineral oils!

²⁾ For standard dimensions list refer to X-SLIDE brochure nr. 18270

Rod seals

 Linear moving
  Rotating
  Oscillating
  Spiral moving
  Static
 Grey symbols: please consult our technical department for application limitations.





App- lication	Profile	Description	Temperature		Speed max.	Pressure		Material		
			min.	max.		max.	max.	Seal	O-ring	
			°C		m/s	bar (psi)	-			
	S21-P	Hydraulic, single-acting O-Ring activated symmetric rod seal with sharp-edged sealing lips, good sealing effect for high viscosity fluids, not recommended for new designs (profile S03-P preferred).	-30	+100	0,5	400 (5 800)	Seal	O-ring		
				-20	+100	0,5	400 (5 800)	ECOPUR	NBR 70	
				-50	+100	0,5	400 (5 800)	H-ECOPUR	NBR 70	
				-20	+100	0,7	400 (5 800)	T-ECOPUR	MVQ 70	
						S-ECOPUR	NBR 70			
	S22-P	Hydraulic, single-acting Symmetric rod seal with support ring for simple applications to serve repair purpose, not recommended for new designs (profile S01-P preferred). Retainer ring in angled design possible.	-30	+100	0,5	400 (5 800)	Seal	Support ring		
				-20	+100	0,5	400 (5 800)	ECOPUR	SKF ECOTAL ¹⁾	
				-20	+100	0,7	400 (5 800)	H-ECOPUR	SKF ECOTAL ¹⁾	
				-40	+100	0,5	400 (5 800)	S-ECOPUR	SKF ECOTAL ¹⁾	
						T-ECOPUR	SKF ECOTAL ¹⁾			
	S22-R	Hydraulic, single-acting Symmetric rod seal as S22-P, but more adaptation possibilities for diverse temperatures and media by selection of suitable seal material. Retainer ring in angled design possible.	-30	+100	0,5	160 (2 300)	Seal	Support ring		
				-20	+200	0,5	160 (2 300)	SKF ECORUBBER-1	SKF ECOTAL	
				-50	+100	0,5	160 (2 300)	SKF ECORUBBER-2	SKF ECOFLON 2	
				-50	+150	0,5	160 (2 300)	SKF ECORUBBER-3 ²⁾	SKF ECOTAL	
				-25	+100	0,5	160 (2 300)	SKF ECORUBBER-3 ²⁾	SKF ECOFLON 2	
				-25	+100	0,5	160 (2 300)	SKF ECORUBBER-H	SKF ECOTAL	
				-25	+150	0,5	160 (2 300)	SKF ECORUBBER-H	SKF ECOFLON 2	
	-10	+200	0,5	160 (2 300)	SKF ECOFLAS	SKF ECOFLON 2				
	S24-P ³⁾	Hydraulic, single-acting O-Ring activated rod seal with additional stabilizing lips and integrated active back ring for larger extrusion gaps, mainly used in mining industry.	-30	+100	0,5	700 (10 000)	Seal	O-ring	Back-up ring	
				-20	+100	0,5	700 (10 000)	ECOPUR	NBR 70	SKF ECOTAL ¹⁾
				-40	+100	0,5	700 (10 000)	H-ECOPUR	NBR 70	SKF ECOTAL ¹⁾
				-20	+100	0,7	700 (10 000)	T-ECOPUR	MVQ 70	SKF ECOTAL ¹⁾
				-20	+100	0,7	700 (10 000)	S-ECOPUR	NBR 70	SKF ECOTAL ¹⁾
				-30	+100	0,5	700 (10 000)	G-ECOPUR	NBR 70	SKF ECOTAL ¹⁾
	S2527-F	PTFE chevron set, single-acting optimized for low pressure, unequal angled chevron design results in good contact pressure even in low pressure range. external spring pretension necessary. mainly used in chemical, pharma and food industry.	-200	+260	1,5	100 (1 450)	S25-F	S26-F	S27-F	
							SKF ECOFLON 2	SKF ECOFLON 1	SKF ECOFLON 2	
	S2931-F	PTFE chevron set, single-acting Optimized for high pressure, equal angled chevron design suitable for high pressure range. External spring pretension necessary. Mainly used in chemical, pharma and food industry.	-200	+260	1,5	315 (4 500)	S29-F	S30-F	S31-F	
							SKF ECOFLON 2	SKF ECOFLON 1	SKF ECOFLON 2	



¹⁾ SKF ECOTAL up to Ø260 mm, SKF ECOMID above Ø260 mm

²⁾ ATTENTION: Not suitable for mineral oils!

³⁾ Upgrade profiles

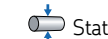
Rod seals

 Linear moving
  Rotating
  Oscillating
  Spiral moving
  Static
 Grey symbols: please consult our technical department for application limitations.

App- lication	Profile	Description	Temperature		Speed max.	Pressure		Material			
			min.	max.		max.	max.	Seal	Support ring		
			°C		m/s	bar (psi)	-				
	S32-P ²⁾	Hydraulic, single-acting Chevron set, design with extremely flexible sealing lips for difficult operating conditions (bad guiding, large tolerance range). Available as total chevron set as well as intermediate chevrons only (in case of metal male and female adaptors).	-30	+100	0,5	500 (7 200)	Pressure ring	Seal	Support ring		
				-20	+100	0,5	500 (7 200)	SKF ECOTAL ¹⁾	ECOPUR ³⁾	SKF ECOTAL ¹⁾	
				-40	+100	0,5	500 (7 200)	SKF ECOTAL ¹⁾	H-ECOPUR	SKF ECOTAL ¹⁾	
				-20	+100	0,7	500 (7 200)	SKF ECOTAL ¹⁾	T-ECOPUR	SKF ECOTAL ¹⁾	
				-20	+100	0,7	500 (7 200)	SKF ECOTAL ¹⁾	S-ECOPUR	SKF ECOTAL ¹⁾	
				-30	+100	0,5	500 (7 200)	X-ECOPUR	ECOPUR	SKF ECOTAL ¹⁾	
				-20	+100	0,5	500 (7 200)	XH-ECOPUR	H-ECOPUR	SKF ECOTAL ¹⁾	
				-20	+100	0,7	500 (7 200)	XS-ECOPUR	S-ECOPUR	SKF ECOTAL ¹⁾	
				-30	+100	0,5	500 (7 200)	G-ECOPUR 54D	G-ECOPUR	SKF ECOTAL ¹⁾	
	S35-P ²⁾	Hydraulic, double-acting Compact rod seal with almost no dead spots as required for applications in food and pharma industry, also commonly used as O-Ring replacement, because design with interference fit on outside diameter maintains non-twisting in dynamic applications.	-30	+110	0,4	400 (5 800)	ECOPUR				
				-20	+110	0,4	400 (5 800)	H-ECOPUR			
				-20	+110	0,5	400 (5 800)	S-ECOPUR			
				-50	+110	0,4	400 (5 800)	T-ECOPUR			
				-30	+110	0,4	400 (5 800)	G-ECOPUR			

¹⁾ SKF ECOTAL up to Ø260 mm, SKF ECOMID above Ø260 mm





















²⁾ Upgrade profiles

³⁾ or G-ECOPUR

Wipers

 Linear moving
  Rotating
  Oscillating
  Spiral moving
  Static

Grey symbols: please consult our technical department for application limitations.









App- lication	Profile	Description	Temperature		Speed max.	Material	
			min.	max.			
			°C		m/s	-	-
   	A01-A	Hydraulic, single-acting Wiper with interference fit on outside diameter, providing a technically accurate closure at the cylinder. Wiping edge assures a reliable protection against penetration of dust and dirt whilst allowing backflow of residual oil film. Back support area prevents tilting of wiper. For housings according ISO 6195–TypeA	-30	+110	4	ECOPUR (X-ECOPUR) ²⁾	
			-20	+110	4	H-ECOPUR /S-ECOPUR	(XH-ECOPUR, XS-ECOPUR) ²⁾
			-50	+110	4	T-ECOPUR	
			-30	+110	4	G-ECOPUR (G-ECOPUR 54D) ²⁾	
			-30	+100	4	SKF ECORUBBER-1	
-25	+150	4	SKF ECORUBBER-H				
-20	+200	4	SKF ECORUBBER-2				
-50	+150	4	SKF ECORUBBER-3 ¹⁾				
-10	+200	4	SKF ECOFLAS				
   	A01-B	Hydraulic, single-acting As profile A01–A, but without back support area. For housings according ISO 6195–TypeA	-30	+110	4	ECOPUR (X-ECOPUR) ²⁾	
			-20	+110	4	H-ECOPUR /S-ECOPUR	(XH-ECOPUR, XS-ECOPUR) ²⁾
			-50	+110	4	T-ECOPUR	
			-30	+100	4	SKF ECORUBBER-1	
			-25	+150	4	SKF ECORUBBER-H	
-20	+200	4	SKF ECORUBBER-2				
-50	+150	4	SKF ECORUBBER-3 ¹⁾				
-10	+200	4	SKF ECOFLAS				
   	A02-A	Hydraulic, single-acting Wiper with interference fit on outside diameter. Wiping edge assures a reliable protection against penetration of dust and dirt whilst allowing backflow of residual oil film. Back support area prevents tilting of wiper.	-30	+110	4	ECOPUR (X-ECOPUR) ²⁾	
			-20	+110	4	H-ECOPUR /S-ECOPUR	(XH-ECOPUR, XS-ECOPUR) ²⁾
			-50	+110	4	T-ECOPUR	
			-30	+110	4	G-ECOPUR (G-ECOPUR 54D) ²⁾	
			-30	+100	4	SKF ECORUBBER-1	
-25	+150	4	SKF ECORUBBER-H				
-20	+200	4	SKF ECORUBBER-2				
-50	+150	4	SKF ECORUBBER-3 ¹⁾				
-10	+200	4	SKF ECOFLAS				
   	A02-B	Hydraulic, single-acting Wiper with interference fit on outside diameter. Wiping edge assures a reliable protection against penetration of dust and dirt whilst allowing backflow of residual oil film.	-30	+110	4	ECOPUR (X-ECOPUR) ²⁾	
			-20	+110	4	H-ECOPUR /S-ECOPUR	(XH-ECOPUR, XS-ECOPUR) ²⁾
			-50	+110	4	T-ECOPUR	
			-30	+110	4	G-ECOPUR (G-ECOPUR 54D) ²⁾	
			-30	+100	4	SKF ECORUBBER-1	
-25	+150	4	SKF ECORUBBER-H				
-20	+200	4	SKF ECORUBBER-2				
-50	+150	4	SKF ECORUBBER-3 ¹⁾				
-10	+200	4	SKF ECOFLAS				
   	A02-I	Hydraulic, single-acting As profile A02–A, but without back support area. Special housing design according ISO 6195–TypeC	-30	+110	4	ECOPUR (X-ECOPUR) ²⁾	
			-20	+110	4	H-ECOPUR /S-ECOPUR	(XH-ECOPUR, XS-ECOPUR) ²⁾
			-50	+110	4	T-ECOPUR	
			-30	+110	4	G-ECOPUR (G-ECOPUR 54D) ²⁾	
			-30	+100	4	SKF ECORUBBER-1	
-25	+150	4	SKF ECORUBBER-H				
-20	+200	4	SKF ECORUBBER-2				
-50	+150	4	SKF ECORUBBER-3 ¹⁾				
-10	+200	4	SKF ECOFLAS				

¹⁾ ATTENTION: Not suitable for mineral oils!
²⁾ Hard grade Polyurethane, please refer to materials list at page 8

Wipers

 Linear moving
  Rotating
  Oscillating
  Spiral moving
  Static

Grey symbols: please consult our technical department for application limitations.

App- lication	Profile	Description	Temperature		Speed max.	Material	
			min.	max.			
			°C		m/s	-	-
   	A03-A	Hydraulic, single-acting Wiper with mounting cage for press-fit installation into axially open housings. Wiping edge assures a reliable protection against penetration of dust and dirt, the use of plastic mounting cages avoids corrosion in the press-fit for housings according ISO 6195–TypeB	-30	+80	4	Seal ECOPUR (X-ECOPUR) ³⁾	Housing SKF ECOTAL ¹⁾
			-20	+80	4	H-ECOPUR (XH-ECOPUR) ³⁾	SKF ECOTAL ¹⁾
			-40	+80	4	T-ECOPUR	SKF ECOTAL ¹⁾
			-20	+80	5	S-ECOPUR (XS-ECOPUR) ³⁾	SKF ECOTAL ¹⁾
			-30	+80	4	SKF ECORUBBER-1	SKF ECOTAL ¹⁾
-25	+80	4	SKF ECORUBBER-H	SKF ECOTAL ¹⁾			
-20	+200	4	SKF ECORUBBER-2	SKF ECOPAЕК			
-50	+150	4	SKF ECORUBBER-3 ²⁾	SKF ECOPAЕК			
-10	+200	4	SKF ECOFLAS	SKF ECOPAЕК			
   	A04-A	Pneumatic, single-acting Wiper with interference fit on outside diameter, providing a technically accurate closure at the cylinder. Special design of wiping lip allows retention of initial lubricating film. Back support area prevents tilting of wiper. For housings according ISO 6195–TypeA	-30	+110	4	ECOPUR (X-ECOPUR) ²⁾	
			-20	+110	4	H-ECOPUR /S-ECOPUR	(XH-ECOPUR, XS-ECOPUR) ³⁾
			-50	+110	4	T-ECOPUR	
			-30	+100	4	SKF ECORUBBER-1	
			-25	+150	4	SKF ECORUBBER-H	
-20	+200	4	SKF ECORUBBER-2				
-50	+150	4	SKF ECORUBBER-3 ²⁾				
-10	+200	4	SKF ECOFLAS				
   	A04-B	Pneumatic, single-acting As profile A04–A, but without back support area. For housings according ISO 6195–TypeA	-30	+110	4	ECOPUR (X-ECOPUR) ³⁾	
			-20	+110	4	H-ECOPUR /S-ECOPUR	(XH-ECOPUR, XS-ECOPUR) ³⁾
			-50	+110	4	T-ECOPUR	
			-30	+100	4	SKF ECORUBBER-1	
			-25	+150	4	SKF ECORUBBER-H	
-20	+200	4	SKF ECORUBBER-2				
-50	+150	4	SKF ECORUBBER-3 ²⁾				
-10	+200	4	SKF ECOFLAS				
   	A05-A	Pneumatic, single-acting Wiper with interference fit on outside diameter. Special design of wiping lip allows retention of initial lubricating film. Back support area prevents tilting of wiper.	-30	+110	4	ECOPUR (X-ECOPUR) ³⁾	
			-20	+110	4	H-ECOPUR /S-ECOPUR	(XH-ECOPUR, XS-ECOPUR) ³⁾
			-50	+110	4	T-ECOPUR	
			-30	+100	4	SKF ECORUBBER-1	
			-25	+150	4	SKF ECORUBBER-H	
-20	+200	4	SKF ECORUBBER-2				
-50	+150	4	SKF ECORUBBER-3 ²⁾				
-10	+200	4	SKF ECOFLAS				
   	A05-B	Pneumatic, single-acting Wiper with interference fit on outside diameter. Special design of wiping lip allows retention of initial lubricating film.	-30	+110	4	ECOPUR (X-ECOPUR) ³⁾	
			-20	+110	4	H-ECOPUR /S-ECOPUR	(XH-ECOPUR, XS-ECOPUR) ³⁾
			-50	+110	4	T-ECOPUR	
			-30	+100	4	SKF ECORUBBER-1	
			-25	+150	4	SKF ECORUBBER-H	
-20	+200	4	SKF ECORUBBER-2				
-50	+150	4	SKF ECORUBBER-3 ²⁾				





¹⁾ SKF ECOTAL up to Ø260 mm, SKF ECOMID above Ø260 mm
²⁾ ATTENTION: Not suitable for mineral oils!
³⁾ Hard grade Polyurethane, please refer to materials list at page 8

App- lication	Profile	Description	Temperature		Speed max.	Material		
			min.	max.				
			°C		m/s	-	-	
	A05-I	Pneumatic, single-acting As profile A05-A, but without back support area. Special housing design according ISO 6195-TypeC	-30	+110	4	ECOPUR (X-ECOPUR) ³⁾	(XH-ECOPUR, XS-ECOPUR) ³⁾	
			-20	+110	4	H-ECOPUR /S-ECOPUR		
			-50	+110	4	T-ECOPUR		
			-30	+100	4	SKF ECORUBBER-1		
			-25	+150	4	SKF ECORUBBER-H		
			-20	+200	4	SKF ECORUBBER-2		
	A06-A	Pneumatic, single-acting Wiper with mounting cage for press-fit installation into axially open housings. Special design of wiping lip allows retention of initial lubricating film, the use of plastic mounting cages avoids corrosion at the press-fit. For housings according ISO 6195-TypeB	-30	+80	4	Seal ECOPUR (X-ECOPUR) ³⁾	Housing SKF ECOTAL ¹⁾	
			-20	+80	4	H-ECOPUR (XH-ECOPUR) ³⁾		SKF ECOTAL ¹⁾
			-40	+80	4	T-ECOPUR		SKF ECOTAL ¹⁾
			-20	+80	5	S-ECOPUR (XS-ECOPUR) ³⁾		SKF ECOTAL ¹⁾
			-30	+80	4	SKF ECORUBBER-1		SKF ECOTAL ¹⁾
			-25	+80	4	SKF ECORUBBER-H		SKF ECOTAL ¹⁾
	A07-A	Hydraulic, single-acting Wiper to fit in angled housings (30°angle). Design mainly used in british equipment, in inch as well as metric dimensions.	-30	+110	4	ECOPUR (X-ECOPUR) ²⁾	(XH-ECOPUR, XS-ECOPUR) ³⁾	
			-20	+110	4	H-ECOPUR /S-ECOPUR		
			-50	+110	4	T-ECOPUR		
			-30	+100	4	SKF ECORUBBER-1		
			-25	+150	4	SKF ECORUBBER-H		
			-20	+200	4	SKF ECORUBBER-2		
	A08-A	Hydraulic/pneumatic, single-acting Wiper usually fixed in housing with clamp flange. Mainly used for replacement in old hydraulic and pneumatic cylinders or for secondary applications.	-30	+110	4	ECOPUR (X-ECOPUR) ³⁾	(XH-ECOPUR, XS-ECOPUR) ³⁾	
			-20	+110	4	H-ECOPUR /S-ECOPUR		
			-50	+110	4	T-ECOPUR		
			-30	+100	4	SKF ECORUBBER-1		
			-25	+150	4	SKF ECORUBBER-H		
			-20	+200	4	SKF ECORUBBER-2		
	A08-B	Hydraulic/pneumatic, single-acting Wiper usually fixed in housing with clamp flange. Mainly used for replacement in old hydraulic and pneumatic cylinders or for secondary applications.	-30	+110	4	ECOPUR (X-ECOPUR) ³⁾	(XH-ECOPUR, XS-ECOPUR) ³⁾	
			-20	+110	4	H-ECOPUR /S-ECOPUR		
			-50	+110	4	T-ECOPUR		
			-30	+100	4	SKF ECORUBBER-1		
			-25	+150	4	SKF ECORUBBER-H		
			-20	+200	4	SKF ECORUBBER-2		

¹⁾ SKF ECOTAL up to Ø260 mm, SKF ECOMID above Ø260 mm

²⁾ ATTENTION: Not suitable for mineral oils!

³⁾ Hard grade Polyurethane, please refer to materials list at page 8









App- lication	Profile	Description	Temperature		Speed max.	Material	
			min.	max.			
			°C		m/s	-	-
	A09-A	Hydraulic, single-acting Wiper with dimensioning according to common types used in USA. For housings according AN 6231, ANSI/B93.35	-30	+110	4	ECOPUR (X-ECOPUR) ²⁾	(XH-ECOPUR, XS-ECOPUR) ²⁾
			-20	+110	4	H-ECOPUR /S-ECOPUR	
			-50	+110	4	T-ECOPUR	
			-30	+100	4	SKF ECORUBBER-1	
			-25	+150	4	SKF ECORUBBER-H	
			-20	+200	4	SKF ECORUBBER-2	
	A10-A	Hydraulic, single-acting Wiper with dimensioning according to common types used in USA. Fixed relation between cross-section and height of wiper. For housings according AN 6231, ANSI/B93.35	-30	+110	4	ECOPUR (X-ECOPUR) ²⁾	(XH-ECOPUR, XS-ECOPUR) ²⁾
			-20	+110	4	H-ECOPUR /S-ECOPUR	
			-50	+110	4	T-ECOPUR	
			-30	+100	4	SKF ECORUBBER-1	
			-25	+150	4	SKF ECORUBBER-H	
			-20	+200	4	SKF ECORUBBER-2	
	A11-A	Hydraulic/pneumatic, double-acting Wiper including additional sealing lip. used in combination with O-ring activated PTFE seals (tandem) to reduce residual oil film. Also used as complete solution for pneumatic applications in small diameter range. max. allowed pressure load: 16 bar (230 psi)	-30	+110	4	ECOPUR	
			-20	+110	4	H-ECOPUR /S-ECOPUR ⁴⁾	
			-50	+110	4	T-ECOPUR	
			-30	+110	4	G-ECOPUR	
			-30	+100	4	SKF ECORUBBER-1	
			-25	+150	4	SKF ECORUBBER-H	
	A11-I	Hydraulic/pneumatic, double-acting As profile A11-A, special housing design according ISO 6195-TypeC	-30	+110	4	ECOPUR	
			-20	+110	4	H-ECOPUR /S-ECOPUR ⁴⁾	
			-50	+110	4	T-ECOPUR	
			-30	+110	4	G-ECOPUR	
			-30	+100	4	SKF ECORUBBER-1	
			-25	+150	4	SKF ECORUBBER-H	
	A12-A ³⁾	Hydraulic, single-acting Wiper with secondary lip, the technically accurate closure at the cylinder is providing reliable protection, even for heavy contamination.	-30	+110	4	ECOPUR (X-ECOPUR) ²⁾	
			-20	+110	4	H-ECOPUR (XH-ECOPUR) ²⁾	
			-50	+110	4	T-ECOPUR	
			-20	+110	5	S-ECOPUR (XS-ECOPUR) ²⁾	

¹⁾ ATTENTION: Not suitable for mineral oils!

²⁾ Hard grade Polyurethane, please refer to materials list at page 8

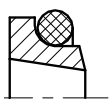
³⁾ Upgrade profile

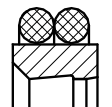
⁴⁾ Speed limit at 5m/s at S-ECOPUR

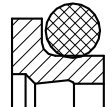
App- lication	Profile	Description	Temperature		Speed	Pressure	Material	
			min.	max.	max.	max.		
			°C		m/s	bar (psi)	-	
 	A12-B ²⁾	Hydraulic, double-acting Wiper including additional sealing lip and secondary lip. Used in combination with tandem seal systems to reduce residual oil film, also used as complete solution for pneumatic applications in small diameter range (max. 16 bar or 230 psi). The technically accurate closure at the cylinder is providing reliable protection, even for heavy contamination.	-30	+110	4	16 (230 psi)	ECOPUR	
			-20	+110	4	16 (230 psi)	H-ECOPUR	
			-50	+110	4	16 (230 psi)	T-ECOPUR	
			-20	+110	5	16 (230 psi)	S-ECOPUR	
 	A13-A	Hydraulic/pneumatic, single-acting Scraper ring, mainly used in combination with wiper A02 or A01. Firmly clinging dirt and extremely heavy soiling (mud, tar, ice) is wiped off, following elastomeric wiper is protected from damage. Recommended materials provide good dry running properties, high stiffness and breaking strength.	-50	+80	1	-	SKF ECOTAL ¹⁾	
			-60	+260	1	-	SKF ECOPA EK	
			-200	+80	1	-	SKF ECOWAER 1000	
			-30	+110	1	-	X-ECOPUR	
			-20	+110	1	-	XH-ECOPUR	
			-20	+110	1	-	XS-ECOPUR	
 	A25-F ²⁾	Hydraulic/pneumatic, single-acting PTFE- or X-ECOPUR-wiper with O-ring as preloading element. PTFE part takes over wiping function, O-ring maintains equal contact pressure. Good dry running properties, no "stick-slip". Excellent chemical and thermal resistance (depends on O-ring).	-30	+100	10	-	Glide ring	
			-20	+200	10	-	SKF ECOFLON 2,3,4	
			-30	+100	5	-	NBR 70	
			-30	+100	5	-	SKF ECOFLON 2,3,4	
			-30	+100	5	-	FPM 75	
			-30	+100	5	-	X-ECOPUR	
			-30	+100	5	-	NBR 70	
			-30	+100	5	-	XH-ECOPUR	
			-30	+100	5	-	NBR 70	
			-30	+100	5	-	XS-ECOPUR	
-30	+100	5	-	NBR 70				
-30	+80	10	-	SKF ECOWEAR 1000				
-55	+80	10	-	NBR 70				
-55	+80	10	-	SKF ECOWEAR 1000				
-55	+80	10	-	MVQ 70				
 	A26-F ²⁾	Hydraulic/pneumatic, double-acting PTFE- or X-ECOPUR-double wiper with two O-rings as preloading elements. Wiping edge assures a reliable protection against penetration of dust and dirt. Additional sealing lip for reduction of residual oil film if used in combination with O-ring activated PTFE seals type S09 (tandem). Excellent chemical and thermal resistance (depends on O-ring).	-30	+100	10	16 (230)	Glide ring	
			-20	+200	10	16 (230)	SKF ECOFLON 2,3,4	
			-30	+100	5	16 (230)	NBR 70	
			-30	+100	5	16 (230)	SKF ECOFLON 2,3,4	
			-30	+100	5	16 (230)	FPM 75	
			-30	+100	5	16 (230)	X-ECOPUR	
			-30	+100	5	16 (230)	NBR 70	
			-30	+100	5	16 (230)	XH-ECOPUR	
			-30	+100	5	16 (230)	NBR 70	
			-30	+100	5	16 (230)	XS-ECOPUR	
			-30	+100	5	16 (230)	NBR 70	
			-30	+100	5	16 (230)	G-ECOPUR 54D	
			-30	+80	10	16 (230)	NBR 70	
			-30	+80	10	16 (230)	SKF ECOWEAR 1000	
-55	+80	10	16 (230)	NBR 70				
-55	+80	10	16 (230)	SKF ECOWEAR 1000				
-55	+80	10	16 (230)	MVQ 70				
 	A27-F ²⁾	Hydraulic/pneumatic, double-acting PTFE- or X-ECOPUR-double wiper with O-ring as preloading element. Wiping edge assures a reliable protection against penetration of dust and dirt. Additional sealing lip for reduction of residual oil film if used in combination with O-ring activated PTFE seals type S09 (tandem). Excellent chemical and thermal resistance (depends on O-ring).	-30	+100	10	16 (230)	Glide ring	
			-20	+200	10	16 (230)	SKF ECOFLON 2,3,4	
			-30	+100	5	16 (230)	NBR 70	
			-30	+100	5	16 (230)	SKF ECOFLON 2,3,4	
			-30	+100	5	16 (230)	FPM 75	
			-30	+100	5	16 (230)	X-ECOPUR	
			-30	+100	5	16 (230)	NBR 70	
			-30	+100	5	16 (230)	XH-ECOPUR	
			-30	+100	5	16 (230)	NBR 70	
			-30	+100	5	16 (230)	XS-ECOPUR	
			-30	+100	5	16 (230)	NBR 70	
			-30	+100	5	16 (230)	G-ECOPUR 54D	
			-30	+80	10	16 (230)	NBR 70	
			-30	+80	10	16 (230)	SKF ECOWEAR 1000	
-55	+80	10	16 (230)	NBR 70				
-55	+80	10	16 (230)	SKF ECOWEAR 1000				
-55	+80	10	16 (230)	MVQ 70				





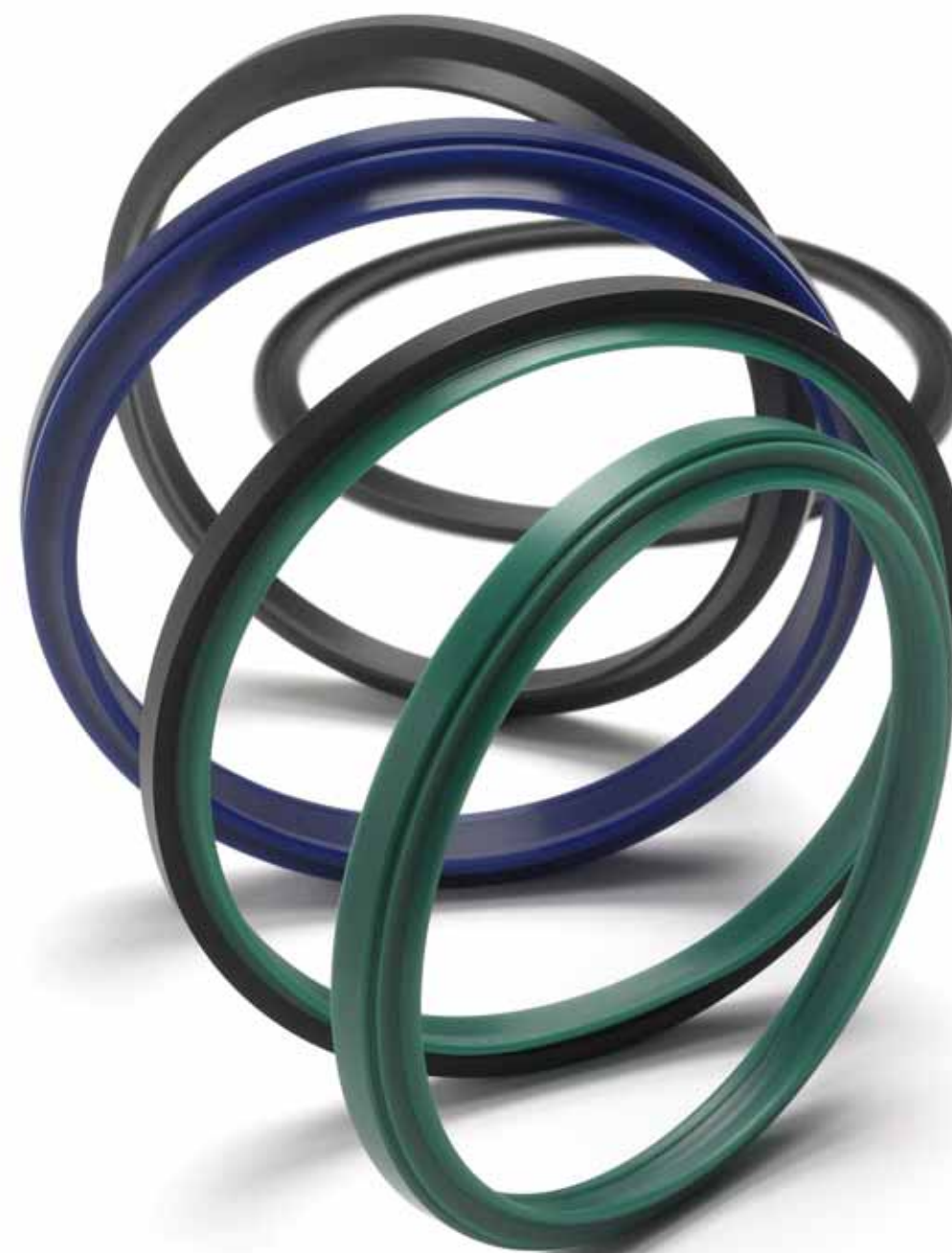

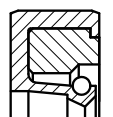

¹⁾ SKF ECOTAL up to Ø260 mm, SKF ECOMID above Ø260 mm

²⁾ Upgrade profile

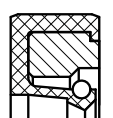

Rotary seals



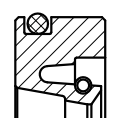





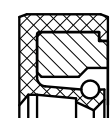

 Linear moving
  Rotating
  Oscillating
  Spiral moving
  Static
 Grey symbols: please consult our technical department for application limitations.

App- lication	Profile	Description	Temperature		Speed max.	Pressure		Material
			min.	max.		bar (psi)	–	
			°C		m/s			
	R01-P	 Single-acting rotary shaft seal Spring loaded lip seal with retainer ring for press-fit installation into axially open housings. Wide range of applications in every sector of industry, mainly as protecting element for bearings.	-30	+80	5	0,5 (7)	Seal ECOPUR H-ECOPUR T-ECOPUR S-ECOPUR G-ECOPUR	Energizer SKF ECOTAL ¹⁾
			-20	+80	5	0,5 (7)		
	R01-R	 Single-acting rotary shaft seal Spring loaded lip seal with retainer ring for press-fit installation into axially open housings. Good adaptation possibilities for diverse temperatures and media by selection of suitable seal material. Wide range of applications in every sector of industry, mainly as protecting element for bearings.	-30	+80	10	0,5 (7)	Seal SKF ECORUBBER-1 SKF ECORUBBER-H SKF ECORUBBER-2 SKF ECORUBBER-3 ²⁾ SKF ECORUBBER-3 ²⁾ SKF ECOSIL SKF ECOSIL SKF ECOFLAS	Energizer SKF ECOTAL ¹⁾ SKF ECOTAL ¹⁾ Metal SKF ECOTAL Metal SKF ECOTAL Metal Metal
			-25	+80	10	0,5 (7)		
	R01-AF	 Single-acting rotary shaft seal Spring loaded lip seal with solid outer section for axially open housings with clamping plate fixation. Mainly used for rolling mills, large gear mechanisms in heavy duty machinery, for shipbuilding industry and civil engineering.	-30	+110	5	0,5 (7)	ECOPUR/G-ECOPUR H-ECOPUR T-ECOPUR S-ECOPUR SKF ECORUBBER-1 SKF ECORUBBER-H SKF ECORUBBER-2 SKF ECORUBBER-3 ²⁾ SKF ECOSIL SKF ECOFLAS	
			-20	+110	5	0,5 (7)		
	R01-AS	 Single-acting rotary shaft seal Split version of a spring loaded lip seal with solid outer section for axially open housings with clamping plate fixation. Mainly used for repair purpose on rolling mills, large gear mechanisms in heavy duty machinery, for shipbuilding industry and civil engineering.	-30	+110	5	0,5 (7)	ECOPUR/G-ECOPUR H-ECOPUR T-ECOPUR S-ECOPUR SKF ECORUBBER-1 SKF ECORUBBER-H SKF ECORUBBER-2 SKF ECORUBBER-3 ²⁾ SKF ECOSIL SKF ECOFLAS	
			-20	+110	5	0,5 (7)		
	R01-F ³⁾	 Single-acting rotary shaft seal Spring loaded PTFE-lip seal for axially open housings with clamping plate fixation, elastic secondary seal or integrated O-ring necessary for static sealing in the housing. Excellent chemical and thermal resistance, allowable pressure and speed depend on each other, it is not recommended to use all maximum values simultaneously.	-30	+100	10	15 (210)	Seal SKF ECOFLON 2,3,4 SKF ECOFLON 2,3,4	O-Ring NBR 70 FPM/FKM 75
			-20	+200	10	15 (210)		

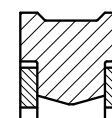
¹⁾ SKF ECOTAL up to Ø260 mm, SKF ECOMID above Ø260 mm
²⁾ ATTENTION: Not suitable for mineral oils!
³⁾ Upgrade profile

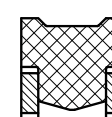
Rotary seals

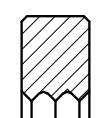

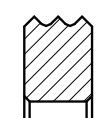

 Linear moving
  Rotating
  Oscillating
  Spiral moving
  Static
 Grey symbols: please consult our technical department for application limitations.

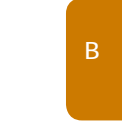

App- lication	Profile	Description	Temperature		Speed max.	Pressure		Material
			min.	max.		bar (psi)	–	
			°C		m/s			
	R02-P	 Single-acting rotary shaft seal As profile R01-P, but with additional dust lip to avoid ingress of dust and dirt.	-30	+80	5	0,5 (7)	Seal ECOPUR H-ECOPUR T-ECOPUR S-ECOPUR G-ECOPUR	Energizer SKF ECOTAL ¹⁾
			-20	+80	5	0,5 (7)		
	R02-R	 Single-acting rotary shaft seal As profile R01-R, but with additional dust lip to avoid ingress of dust and dirt.	-30	+80	10	0,5 (7)	Seal SKF ECORUBBER-1 SKF ECORUBBER-H SKF ECORUBBER-2 SKF ECORUBBER-3 ²⁾ SKF ECORUBBER-3 ²⁾ SKF ECOSIL SKF ECOSIL SKF ECOFLAS	Energizer SKF ECOTAL ¹⁾ SKF ECOTAL ¹⁾ Metal SKF ECOTAL Metal Metal Metal
			-25	+80	10	0,5 (7)		
	R03-P	 Double-acting rotary seal Rotary seal with integrated backup rings for pivoting motion in hydraulic systems. Interference fit on outside diameter maintains stable fit in the housing, back-up rings permit larger extrusion gap / higher pressure. Mainly used for rotary pivots on excavators, grabs.	-30	+100	0,2	400 (5 800)	Seal ECOPUR H-ECOPUR T-ECOPUR S-ECOPUR	Back-up rings SKF ECOTAL ¹⁾ SKF ECOTAL ¹⁾ SKF ECOTAL ¹⁾ SKF ECOTAL ¹⁾
			-20	+100	0,2	400 (5 800)		
	R03-R	 Double-acting rotary seal As profile R03-P but more adaptation possibilities for diverse temperatures and media by selection of suitable seal material.	-30	+100	0,2	250 (3 600)	Seal SKF ECORUBBER-1 SKF ECORUBBER-H SKF ECORUBBER-2	Back-up rings SKF ECOTAL ¹⁾ SKF ECOTAL ¹⁾ SKF ECOFLON 2
			-25	+100	0,2	250 (3 600)		
	R04-A	 Double-acting rotary seal Space saving rotary seal for pivoting motion in hydraulic systems. Interference fit on outside diameter maintains stable fit in the housing, dynamic sealing lips on inside diameter.	-30	+110	0,2	160 (2 300)	ECOPUR H-ECOPUR T-ECOPUR S-ECOPUR SKF ECORUBBER-1 SKF ECORUBBER-H SKF ECORUBBER-2 SKF ECORUBBER-3 ²⁾ SKF ECOFLAS	
			-20	+110	0,2	160 (2 300)		
	R05-A	 Double-acting rotary seal Space saving rotary seal for pivoting motion in hydraulic systems. Interference fit on inside diameter maintains stable fit in the housing, dynamic sealing lips on outside diameter.	-30	+110	0,2	160 (2 300)	ECOPUR H-ECOPUR T-ECOPUR S-ECOPUR SKF ECORUBBER-1 SKF ECORUBBER-H SKF ECORUBBER-2 SKF ECORUBBER-3 ²⁾ SKF ECOFLAS	
			-20	+110	0,2	160 (2 300)		

¹⁾ SKF ECOTAL up to Ø260 mm, SKF ECOMID above Ø260 mm
²⁾ ATTENTION: Not suitable for mineral oils!

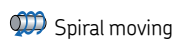



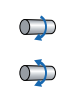
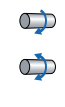
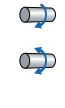

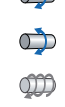
Rotary seals





 Linear moving
  Rotating
  Oscillating
  Spiral moving
  Static
 Grey symbols: please consult our technical department for application limitations.

App- lication	Profile	Description	Temperature		Speed	Pressure	Material
			min.	max.	max.	max.	
			°C		m/s	bar (psi)	–
	R06-P	Axially acting rotary seal Elastic, excellent wear resistant V-Ring with interference fit on the shaft, rotates with the shaft, sealing axially against shaft collars, thrust blocks or the outer race of roller bearings, protecting the bearing against dust, dirt, oil splash, watersplash and similar media. Acting as a seal- and slingerring.	-30	+110	25	–	ECOPUR
			-20	+110	25	–	H-ECOPUR
			-50	+110	25	–	T-ECOPUR
			-20	+110	25	–	S-ECOPUR
			-30	+110	25	–	G-ECOPUR
	R06-R	Axially acting rotary seal Elastic, good wear resistant V-Ring as profile R06-P, but more adaptation possibilities for diverse temperatures and media by selection of suitable seal material.	-30	+100	25	–	SKF ECORUBBER-1
			-20	+200	25	–	SKF ECORUBBER-2
			-50	+150	25	–	SKF ECORUBBER-3 ¹⁾
			-25	+150	25	–	SKF ECORUBBER-H
			-10	+200	25	–	SKF ECOFLAS
	R07-P	Axially acting rotary seal Elastic, excellent wear resistant V-Ring with interference fit on the shaft, rotates with the shaft, sealing axially against shaft collars, thrust blocks or the outer race of roller bearings, protecting the bearing against dust, dirt, oil splash, watersplash and similar media. Acting as a seal- and slingerring.	-30	+110	25	–	ECOPUR
			-20	+110	25	–	H-ECOPUR
			-50	+110	25	–	T-ECOPUR
			-20	+110	25	–	S-ECOPUR
			-30	+110	25	–	G-ECOPUR
	R07-R	Axially acting rotary seal Elastic, good wear resistant V-Ring as profile R07-P, but more adaptation possibilities for diverse temperatures and media by selection of suitable seal material.	-30	+100	25	–	SKF ECORUBBER-1
			-20	+200	25	–	SKF ECORUBBER-2
			-50	+150	25	–	SKF ECORUBBER-3 ¹⁾
			-25	+150	25	–	SKF ECORUBBER-H
			-10	+200	25	–	SKF ECOFLAS
	R08-A	Single-acting rotary seal Springless rotary lip seal with arbitrary preload on inside and outside diameter in order to design the seal to different specific needs.	²⁾		²⁾	²⁾	²⁾
	R09-F	Double-acting rotary seal O-ring activated, low friction PTFE rotary seal. Mainly used in applications with alternating pressure from one side of the seal to the other, such as hose reels, swivel joints, rotating track rings and machine tool hydraulics. Good chemical and thermal resistance achievable by selection of suitable O-ring material.	-30	+100	0,4	350 (5 000)	Glide ring SKF ECOFLON 2,3,4
							Energizer NBR 70

¹⁾ ATTENTION: Not suitable for mineral oils!
²⁾ Upon application

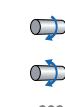
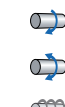



Rotary seals

 Linear moving
  Rotating
  Oscillating
  Spiral moving
  Static
 Grey symbols: please consult our technical department for application limitations.





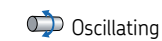
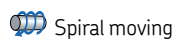

App- lication	Profile	Description	Temperature		Speed	Pressure	Material
			min.	max.	max.	max.	
			°C		m/s	bar (psi)	–
	R09-FS	Double-acting rotary seal As profile R09-F, but with a profile ring energizer instead of the O-ring. For heavy duty applications and non standard housings.	-30	+100	0,4	350 (5 000)	Glide ring SKF ECOFLON 2,3,4
							Energizer SKF ECORUBBER-1
	R10-F	Double-acting rotary seal O-ring activated, low friction PTFE rotary seal. Mainly used in applications with alternating pressure from one side of the seal to the other, such as hose reels, swivel joints, rotating track rings and machine tool hydraulics. Good chemical and thermal resistance achievable by selection of suitable O-ring material.	-30	+100	0,4	350 (5 000)	Glide ring SKF ECOFLON 2,3,4
							Energizer NBR 70
	R10-FS	Double-acting rotary seal As profile R10-F, but with a profile ring energizer instead of the O-ring. For heavy duty applications and non standard housings.	-30	+100	0,4	350 (5 000)	Glide ring SKF ECOFLON 2,3,4
							Energizer SKF ECORUBBER-1
	R11-F ²⁾	Single-acting PTFE rotary seal Space saving rotary seal, deformed sealing lip acts selfadjusting on increasing temperature. For axially open housings with clamping plate fixation, elastic secondary seal or integrated O-ring necessary for static sealing in the housing. Excellent chemical and thermal resistance, suitable for high speed applications.	-200	+260	20	5 (70)	SKF ECOFLON 2,3,4
	R12-F ²⁾	Single-acting PTFE flange seal Fingerspring activated flange seal, excellent chemical and thermal resistance, mainly used on flanges, fittings or pivoting joints in chemical industry.	-200	+260	1	300 (4 300)	Seal SKF ECOFLON 1,2,3,4
							Spring ³⁾ 1.4310
	R13	O-ring Well known, simple O-ring with proven reliability in multiple applications in every sector of industry. Excellent adaptation possibilities for diverse temperatures and media by selection of suitable seal material. Mainly used as static seal or as preloading element for PTFE-seals. For most dynamic applications we recommend to prefer profiles like S20/K20 or S35/K35.	-30	+110	–	600 (8 700)	ECOPUR/G-ECOPUR
			-20	+110	–	600 (8 700)	H-ECOPUR/S-ECOPUR
			-50	+110	–	600 (8 700)	T-ECOPUR
			-30	+100	–	160 (2 300)	SKF ECORUBBER-1
			-20	+200	–	160 (2 300)	SKF ECORUBBER-2
-50	+50	–	160 (2 300)	SKF ECORUBBER-3 ¹⁾			
-25	+150	–	160 (2 300)	SKF ECORUBBER-H			
-200	+260	–	160 (2 300)	SKF ECOFLON 1			
-60	+200	–	160 (2 300)	SKF ECOSIL			
-10	+200	–	160 (2 300)	SKF ECOFLAS			

¹⁾ ATTENTION: Not suitable for mineral oils!
²⁾ Upgrade profile
³⁾ Spring metal material definition

Rotary seals

 Linear moving
  Rotating
  Oscillating
  Spiral moving
  Static





Grey symbols: please consult our technical department for application limitations.

App- lication	Profile	Description	Temperature		Speed	Pressure	Material
			min.	max.	max.	max.	
			°C		m/s	bar (psi)	–
	R14	Square ring Well known, simple square ring, mainly used for static applications or as gaskets. Excellent adaptation possibilities for diverse temperatures and media by selection of suitable seal material.	2)		2)	2)	2)
	R15-P	Double-acting static seal For static applications as an O-ring replacement to avoid drilling in the housing, simple installation and higher extrusion resistance.	-30	+110	–	400 (5800)	ECOPUR
			-20	+110	–	400 (5800)	H-ECOPUR
			-50	+110	–	400 (5800)	T-ECOPUR
			-20	+110	–	400 (5800)	S-ECOPUR
	R16 ³⁾	Double-acting static seal For static and dynamic applications as an O-ring replacement in radial and axial grooves.	-30	+110	–	50 (3600)	SKF ECORUBBER-1
			-20	+200	–	50 (3600)	SKF ECORUBBER-2
			-50	+150	–	50 (3600)	SKF ECORUBBER-3 ⁴⁾
			-25	+150	–	50 (3600)	SKF ECORUBBER-H
			-10	+200	–	50 (3600)	SKF ECOFLAS
	R19-F ³⁾	Single-acting PTFE rotary seal Fingerspring activated PTFE seal with integrated clamping flange on the back of seal for clamping fixation, acting as anti-twist device. Excellent chemical and thermal resistance. Suitable for relatively high pressure and high speed, however, allowable pressure and speed depend on each other, it is not recommended to use all maximum values simultaneously.	-200	+260	2	150 (2100)	Seal SKF ECOFLON 1,2,3,4
							Spring 1.4310 ⁵⁾
	R20-P ³⁾	Single-acting flange seal Flange seal for static applications, suitable for high pressure range. Direction of pressurization (from inside or outside) must be indicated when ordering the seal.	-30	+110	–	800 (11 600)	ECOPUR
			-20	+110	–	800 (11 600)	H-ECOPUR
			-50	+110	–	800 (11 600)	T-ECOPUR
			-20	+110	–	800 (11 600)	S-ECOPUR
	R30-A ³⁾	Valve stem seal with PTFE jacket For low friction, rubber energizer automatically increases preload as it senses leakage. Mainly used as valve seal in oil industry/off-shore applications.	-20	+100	0,5	500 (7200)	Seal SKF ECORUBBER-2
			-25	+100	0,5	500 (7200)	SKF ECORUBBER-H
			-20	+200	0,5	1 000 (14 500)	SKF ECORUBBER-2
			-25	+200	0,5	1 000 (14 500)	SKF ECORUBBER-H
							Cover SKF ECOFLON ⁴⁾
							Back-up ring SKF ECOTAL ⁶⁾

¹⁾ ATTENTION: Not suitable for mineral oils!
²⁾ Upon application
³⁾ Upgrade profile

⁴⁾ All types of SKF ECOFLON (1,2,3,4...), please refer to materials list t page 8
⁵⁾ Spring metal material definition
⁶⁾ SKF ECOTAL up to Ø260 mm, SKF ECOMID above Ø260 mm

Rotary seals





 Linear moving
  Rotating
  Oscillating
  Spiral moving
  Static







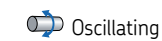











Grey symbols: please consult our technical department for application limitations.

App- lication	Profile	Description	Temperature		Speed	Pressure	Material
			min.	max.	max.	max.	
			°C		m/s	bar (psi)	–
	R35-A ²⁾	Single-acting flange seal Flange seal for static applications, suitable for high pressure range. Direction of pressurization (from inside or outside) must be indicated when ordering the seal.	-30	+110	–	800 (11 600)	ECOPUR/G-ECOPUR
			-20	+110	–	800 (11 600)	H-ECOPUR
			-50	+110	–	800 (11 600)	T-ECOPUR
			-20	+110	–	800 (11 600)	S-ECOPUR
			-30	+100	–	250 (3 600)	SKF ECORUBBER-1
			-20	+200	–	250 (3 600)	SKF ECORUBBER-2
			-50	+150	–	250 (3 600)	SKF ECORUBBER-3 ⁴⁾
			-25	+150	–	250 (3 600)	SKF ECORUBBER-H
			-60	+200	–	250 (3 600)	SKF ECOSIL
			-10	+200	–	250 (3 600)	SKF ECOFLAS

¹⁾ ATTENTION: Not suitable for mineral oils!
²⁾ Upgrade profile

Guide rings

 Linear moving
  Rotating
  Oscillating
  Spiral moving
  Static
 Grey symbols: please consult our technical department for application limitations.





App- lication	Profile	Description	Temperature		Speed max.	Specific load ³⁾ max.	Material
			min.	max.			
			°C		m/s	N/mm ²	-
  	F01	Guide ring Most common guide ring for rod or piston application. Used in many standard cylinders, majority of applications require split version for installation into closed housings, non split design available (bushings).	-50	+100	4	25	SKF ECOTAL ¹⁾
			-200	+200	4	3	SKF ECOFLON 2
			-200	+200	5	4,5	SKF ECOFLON 3
			-200	+200	5	7,5	SKF ECOFLON 60 % Bz.
			-40	+130	1	90	SKF ECOTEX ²⁾
  	F02	Guide ring For rod or piston application, split and non split design available. Not only used as guiding, also as plain washer or spacer.	-50	+100	4	25	SKF ECOTAL ¹⁾
			-200	+200	4	3	SKF ECOFLON 2
			-200	+200	5	4,5	SKF ECOFLON 3
			-200	+200	5	7,5	SKF ECOFLON 60 % Bz.
			-40	+130	1	90	SKF ECOTEX ²⁾
  	F03	Guide ring F03 for piston application. angled design combines guiding and back-up ring function. split and non split design available.	-50	+100	4	25	SKF ECOTAL ¹⁾
			-200	+200	4	3	SKF ECOFLON 2
			-200	+200	5	4,5	SKF ECOFLON 3
			-200	+200	5	7,5	SKF ECOFLON 60 % Bz.
			-40	+130	1	90	SKF ECOTEX ²⁾
  	F04	Guide ring F04 As profile F03 but for rod application.	-50	+100	4	25	SKF ECOTAL ¹⁾
			-200	+200	4	3	SKF ECOFLON 2
			-200	+200	5	4,5	SKF ECOFLON 3
			-200	+200	5	7,5	SKF ECOFLON 60 % Bz.
			-40	+130	1	90	SKF ECOTEX ²⁾
  	F05	Guide ring F05 With integrated collar on inside diameter, for piston application. Split and non split design available.	-50	+100	4	25	SKF ECOTAL ¹⁾
			-200	+200	4	3	SKF ECOFLON 2
			-200	+200	5	4,5	SKF ECOFLON 3
			-200	+200	5	7,5	SKF ECOFLON 60 % Bz.
			-40	+130	1	90	SKF ECOTEX ²⁾
  	F06	Guide ring F06 With integrated collar on outside diameter, for rod application. Split and non split design available.	-50	+100	4	25	SKF ECOTAL ¹⁾
			-200	+200	4	3	SKF ECOFLON 2
			-200	+200	5	4,5	SKF ECOFLON 3
			-200	+200	5	7,5	SKF ECOFLON 60 % Bz.
			-40	+130	1	90	SKF ECOTEX ²⁾







¹⁾ SKF ECOTAL up to Ø260 mm, SKF ECOMID above Ø260 mm

²⁾ Ecotex: Special fabric reinforced material

³⁾ depending on temperature and allowable compression

Guide rings









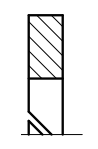

 Linear moving
  Rotating
  Oscillating
  Spiral moving
  Static
 Grey symbols: please consult our technical department for application limitations.

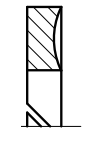
App- lication	Profile	Description	Temperature		Speed max.	Specific load ³⁾ max.	Material
			min.	max.			
			°C		m/s	N/mm ²	-
  	F07	Guide ring F07 With groove on inside diameter, for piston application. Split and non split design available.	-50	+100	4	25	SKF ECOTAL ¹⁾
			-200	+200	4	3	SKF ECOFLON 2
			-200	+200	5	4,5	SKF ECOFLON 3
			-200	+200	5	7,5	SKF ECOFLON 60 % Bz.
			-40	+130	1	90	SKF ECOTEX ²⁾
  	F08	Guide ring F08 With groove on outside diameter, for rod application. Split and non split design available.	-50	+100	4	25	SKF ECOTAL ¹⁾
			-200	+200	4	3	SKF ECOFLON 2
			-200	+200	5	4,5	SKF ECOFLON 3
			-200	+200	5	7,5	SKF ECOFLON 60 % Bz.
			-40	+130	1	90	SKF ECOTEX ²⁾

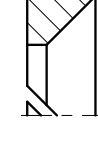
¹⁾ SKF ECOTAL up to Ø260 mm, SKF ECOMID above Ø260 mm

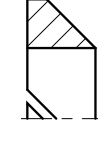
²⁾ Ecotex: Special fabric reinforced material

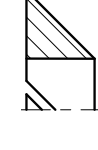
³⁾ depending on temperature and allowable compression

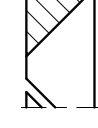
App- lication	Profile	Description	Temperature		Speed max.	Pressure max.	Material	Energizer
			min.	max.				
			°C		m/s	bar (psi)		
 	ST08	Back-up ring Common inactive back-up ring, mainly used with O-rings to avoid gap extrusion. Split and non split design available.	-50	+100	-	-	SKF ECOTAL ¹⁾	Energizer
			-200	+260	-	-	SKF ECOFLON 1	-
			-200	+260	-	-	SKF ECOFLON 2	-
			-30	+110	-	-	ECOPUR	-
			-20	+110	-	-	H-ECOPUR	-
			-50	+110	-	-	T-ECOPUR	-
			-30	+110	-	-	G-ECOPUR	-
-30	+110	5	16 (230)	X-ECOPUR	NBR 70			
 	ST09	Back-up ring Common inactive back-up ring especially for O-rings to avoid gap extrusion. Split and non split design available.	-200	+260	-	-	SKF ECOFLON 1	Energizer
			-30	+110	-	-	ECOPUR	-
			-20	+110	-	-	H-ECOPUR	-
			-50	+110	-	-	T-ECOPUR	-
			-30	+110	-	-	G-ECOPUR	-
			-30	+110	5	16 (230)	X-ECOPUR	NBR 70
 	ST10	Back-up ring Standard active back-up ring for piston seal type PD. Normally already included in PD-type seal profiles, designed for automatic pressure activation. Split and non split design available.	-50	+100	-	-	SKF ECOTAL ¹⁾	
			-200	+260	-	-	SKF ECOFLON 2	
 	ST11	Back-up ring Standard active back-up ring for rod seal type PD. Normally already included in PD-type seal profiles, designed for automatic pressure activation. Split and non split design available.	-50	+100	-	-	SKF ECOTAL ¹⁾	
			-200	+260	-	-	SKF ECOFLON 2	
 	ST12	Back-up ring Triangular back-up ring for rod applications, fits in special shaped housings (see seal data sheets). Also used as integrated active back-up ring in special high pressure or low friction seal profiles. Split and non split design available.	-50	+100	-	-	SKF ECOTAL ¹⁾	
			-200	+260	-	-	SKF ECOFLON 2	
 	ST13	Back-up ring Triangular back-up ring for piston applications, fits in special shaped housings (see seal data sheets). Also used as integrated active back-up ring in special high pressure or low friction seal profiles. Split and non split design available.	-50	+100	-	-	SKF ECOTAL ¹⁾	
			-200	+260	-	-	SKF ECOFLON 2	







¹⁾ SKF ECOTAL up to Ø260 mm, SKF ECOMID above Ø260 mm

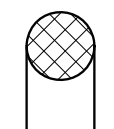
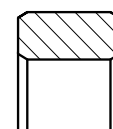
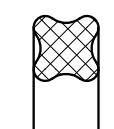

Static seals

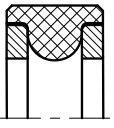
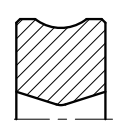
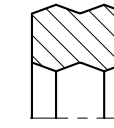
Beside the conventional O-rings and square-rings SKF Economos offers a standard range of specialised seals for static applications. Most of below listed profiles fit in standard

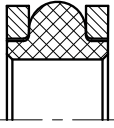
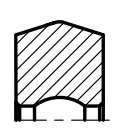
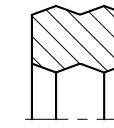
O-ring-grooves (housings) and can be substituted easily without any rework of housing dimensions.

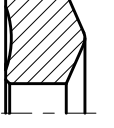
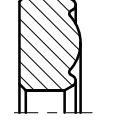
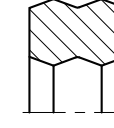
Static	Profiles	Description
	  	Universal type Most common and simple seal profiles with proven reliability in multiple applications in every sector of industry.
	  	Inside sealing type Interference fit on outside diameter assures stable fit in the housing and reliable performance at all pressures.
	  	Outside sealing type Interference fit on inside diameter assures stable fit in the housing and reliable performance at all pressures.
	  	Axial sealing type Robust profiles mainly used as flange seals, inside or outside pressurization possible. Direction of pressurization (from inside or outside) must be indicated when ordering the seal.

Tailormade solutions

In addition to our standard range of static seals we certainly do offer special tailormade static seal profiles to satisfy the very specific needs of every customer, in every industry.

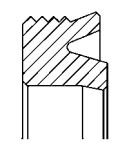
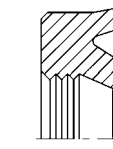
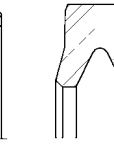
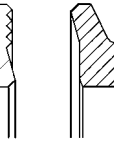
Static	Profiles	Description
	   	Tailormade solutions These special profiles are examples for our wide and flexible product range.



Piston seal housing details and recommendations

The listing beside is our suggestion for standard housing dimensions. Please note that we are able to produce those profiles to your specific need or any non standard housing.

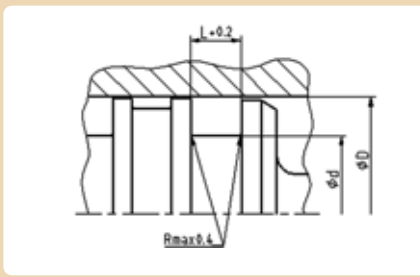

Indicated dimensions are required to process an order:

- D bore diameter
- d housing groove diameter
- L housing groove length
- c/s cross section







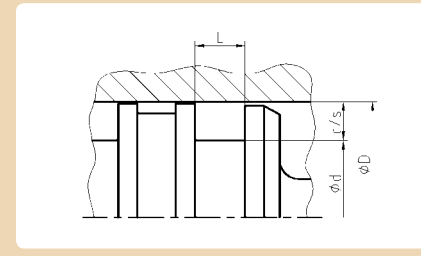

Surface properties		R_{tmax}	R_a
		μm	μm
Sliding surface for PU/rubber seals		$\leq 2,5$	$\leq 0,1 - 0,5$
PTFE seals		≤ 2	$\leq 0,05 - 0,3$
Groove bottom		$\leq 6,3$	$\leq 1,6$
Groove face		≤ 15	≤ 3
Bearing area T_p		50 – 95%	

Seal housing tolerances

- D H9
- d h10

Table 1

Main function:
Single-acting piston seals lip type (U-cup) seals compact seals.

Main applications:
Support and retaining cylinders, standard cylinders.



Advantages:
Stable fit in the housing, ultimate sealing effect, wide temperature range.

Standard materials:
ECOPUR, SKF ECORUBBER (all types).

Bore diameter	Housing groove diameter		Housing groove length L	Cross section c/s
	D over	incl.		
mm	–	mm	mm	mm
14	24,9	D–8	6	4
25	49,9	D–10	7	5
50	74,9	D–12	8	6
75	149,9	D–15	10	7,5
150	299,9	D–20	12	10
300	500	D–25	18	12,5
500	750*	D–30	20	15
750*		D–40	26	20

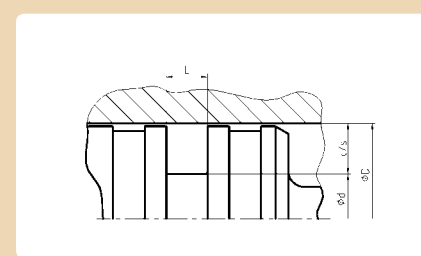
* not all profiles available above 600mm

Main function:
Single/double-acting piston seals, o-ring activated PTFE (PU) seals.

Main applications:
Standard cylinders for positioning functions, mobile hydraulics, etc.

Advantages:
Low friction, no stick-slip, excellent resistance against pressure shocks.

Standard materials:
SKF ECOFLON/NBR or SKF ECOFLON/Viton X-ECOPUR/NBR.

Bore diameter	Housing groove diameter		Housing groove length L	Cross section c/s
	D over	incl.		
mm	–	mm	mm	mm
8	14,9	D–4,9	2,2	2,45
15	39,9	D–7,5	3,2	3,75
40	79,9	D–11	4,2	5,5
80	132,9	D–15,5	6,3	7,75
133	329,9	D–21	8,1	10,5
330	669,9	D–24,5	8,1	12,25
670	1 000	D–28	9,5	14 ¹⁾
>1 000	2 000	D–38	9,5	19 ¹⁾

¹⁾ Only profiles K08-D and K08-E, not for profile K08-P

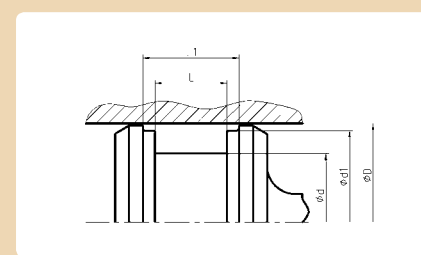

Main function:
Double-acting piston seal, compact type.

Main applications:
Support- and retaining cylinders, standard cylinders.

Advantages:
excellent static and dynamic sealing capacity, integrated back-up rings.

Standard materials:
ECOPUR / SKF ECORUBBER / SKF ECOTAL.

Bore diameter	Housing groove diameter		Housing groove length	
	D over	incl.	$L_1^{1)}$	$L_1^{1)}$
mm	–	mm	mm	–
20	49,9	10	3	12,5
50	79,9	15	4	20
80	149,9	20	5	25
150	399,9	25	6	32
400	600	30	8	36
				50

¹⁾ Not valid for profile K09-H

Rod seal housing details and recommendations

The listing beside is our suggestion for standard housing dimensions. Please note that we are able to produce those profiles to your specific need or any non standard housing.

Table 2

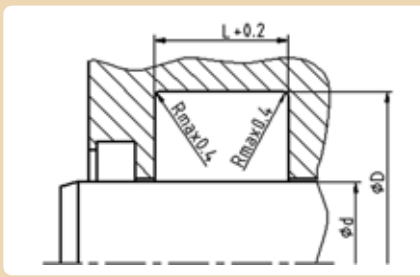



Indicated dimensions are required to process an order:

- D housing groove diameter
- d rod diameter
- L housing groove length
- c/s cross section

Surface properties	R_{tmax}	R_a
	μm	μm
Sliding surface for PU/rubber seals	$\leq 2,5$	$\leq 0,1 - 0,5$
PTFE seals	≤ 2	$\leq 0,05 - 0,3$
Groove bottom	$\leq 6,3$	$\leq 1,6$
Groove face	≤ 15	≤ 3
Bearing area T_p	50 – 95%	

Seal housing tolerances

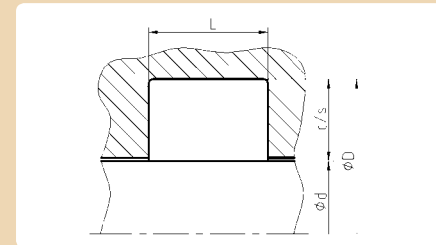
- D f8
- d h10

Main function:
Single-acting rod seals lip type (U-cup) seals compact seals.



Main applications:
Standard cylinders, light and standard hydraulic applications.

Advantages:
Stable fit in the housing, ultimate sealing effect, wide temperature range, good backpumping ability.

Standard materials:
ECOPUR, SKF ECORUBBER

Rod diameter	Housing groove diameter D	Housing groove length L	Cross section c/s
d over	incl.	mm	mm
5	24,9 ¹⁾	d+8	6,3
25	49,9	d+10	8
50	149,9	d+15	10
150	299,9	d+20	14
300	499,9	d+25	17
500	699,9*	d+30	25
700	1 000*	d+40	32
>1 000	>1 000*	d+40	32

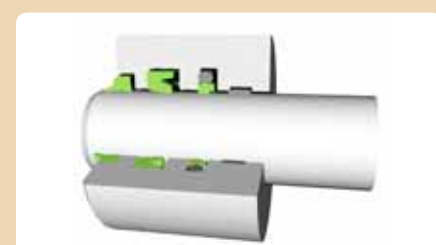
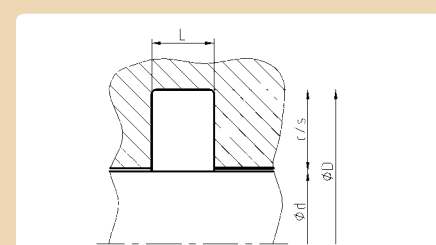
* not all profiles available above 600mm

Main function:
Single/double-acting rod seals, O-ring activated PTFE (PU) seals.

Main applications:
Earth moving equipment, heavy hydraulics.



Advantages:
Excellent resistance against pressure shocks, long lifetime.

Standard materials:

- S09: SKF ECOFLON/NBR or SKF ECOFLON/Viton, X-ECOPUR/NBR
- S01: ECOPUR or SKF ECORUBBER.

Rod diameter	Housing groove diameter D	Housing groove length L	Cross section c/s
d over	incl.	mm	mm
5	7,9	d+4,9	2,2
8	18,9	d+7,3	3,2
19	37,9	d+10,7	4,2
38	199,9	d+15,1	6,3
200	255,9	d+20,5	8,1
256	649,9*	d+24	8,1
650	1 000*	d+27,3	9,5
>1 000	>1 000*	d+27,3	9,5

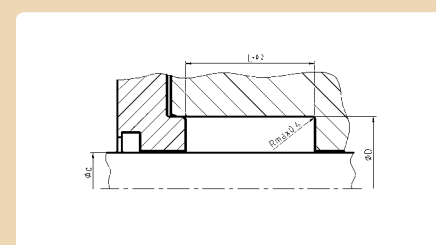
* not all profiles available above 600mm

Main function:
Single-acting rod seals chevron packings.

Main applications:
Heavy industry hydraulics, presses.

Advantages:
Suitable for old, worn rods, splitted version for easy installation available.

Standard Materials:
SKF ECOPUR / SKF ECOTAL.

Rod diameter	Housing groove diameter D	Housing groove length L	Cross section c/s
d over	incl.	mm	mm
10	39,9	d+10	16
40	74,9	d+15	25
75	149,9	d+20	32
150	199,9	d+25	40
200	300	d+30	50
>300	>300	d+40	63

¹⁾ Restrictions in minimum diameter for profiles with back-up rings. Please consult our technical department for exact limitations.

Wiper housing details and recommendations

The listing beside is our suggestion for standard housing dimensions. Please note that we are able to produce those profiles to your specific need or any non standard housing.

Table 3

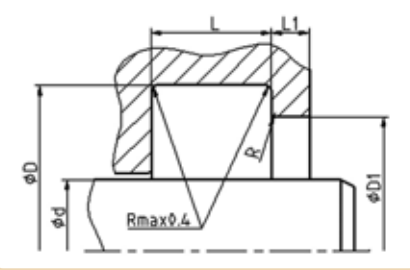

Indicated dimensions are required to process an order:

- D housing groove diameter
- d rod diameter
- L housing groove width
- H total wiper height

Surface properties		R_{tmax}	R_a
		μm	μm
Sliding surface for PU/rubber seals		$\leq 2,5$	$\leq 0,1 - 0,5$
PTFE seals		≤ 2	$\leq 0,05 - 0,3$
Groove bottom		$\leq 6,3$	$\leq 1,6$
Groove face		≤ 15	≤ 3
Bearing area T_p		50 – 95%	
Seal housing tolerances			
• D_1 H11		$L < 10 \text{ mm} +0,2$	
• D H11		$L > 10 \text{ mm} +0,3$	



A01 A04

Rod diameter		Housing groove diameter		Housing groove width		Total wiper height
d over	incl.	D	D_1	L	L_1	H
mm	-	mm	-	mm	-	mm
6	100	d+8	d+6	4	1	7
100,1	149,9	d+12	d+9	5,5	1,5	10
≥ 150	≥ 150	d+15	d+11	6,5	2	13

Main function:
Single-acting wipers.

Main applications:
Standard wiper for hydraulics.

Advantages:
Easy installation (snap-in), excellent wear resistance, technically accurate closure.

Standard materials:
ECOPUR (X-) / SKF ECORUBBER.

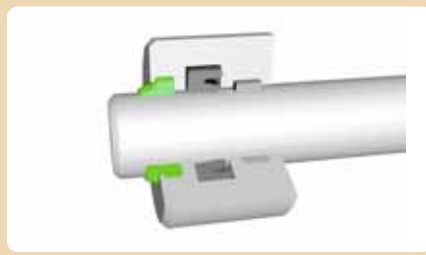

A02 A05 A11

Rod diameter		Housing groove diameter		Housing groove width		Total wiper height
d over	incl.	D	D_1	L	L_1 min	H
mm	-	mm	-	mm	-	mm
6	49,9	d+8	d+4	5	2	8
99,9	d+10	d+5	6	2	9,7	10
≥ 100	d+15	d+7,5	8,5	2	13	13

Main function:
Single/double-acting wipers.

Main applications:
In combination with O-ring activated PTFE rod seals (S09).

Advantages:
Excellent wear resistance, double-acting function.

Standard materials:
ECOPUR (X-ECOPUR) / SKF ECORUBBER.



A03 A06

Rod diameter		Housing groove diameter		Housing groove width		Total wiper height
d over	incl.	D	D_1	L	L_1	H
mm	-	mm	-	mm	-	mm
6	9,9	d+8	-	5	-	8
10	99,9	d+10	-	7	-	10
100	200	d+15	-	9	-	12
>200	>200	d+20	-	12	-	16

Main function:
Single-acting wipers.

Main applications:
Standard hydraulic applications, pressfit for axially open housings.

Advantages:
Excellent wear resistance, plastic retainer ring, no oxidation problem between retainer and housing.

Standard materials:
ECOPUR (X-) + SKF ECOTAL / SKF ECORUBBER + SKF ECOTAL.

Rotary seal housing details and recommendations

The listing beside is our suggestion for standard housing dimensions. Please note that we are able to produce those profiles to your specific need or any non standard housing.

Indicated dimensions are required to process an order:

- D housing groove diameter
- d shaft diameter
- L housing groove length
- c/s cross section

Surface properties		R_{tmax}	R_a
		μm	μm
Sliding surface for PU/rubber seals		$\leq 2,5$	$\leq 0,1 - 0,5$
PTFE seals		≤ 2	$\leq 0,05 - 0,3$
Groove bottom		$\leq 6,3$	$\leq 1,6$
Groove face		≤ 15	≤ 3
Bearing area T_p		50 – 95%	

Seal housing tolerances

- D H8
- d f8

Table 4

R01 R02

Main function:
Single-acting rotary seals, oil seals/radial shaft seals.

Main applications:
Bearing protection.

Advantages:
Good adaptation possibilities for diverse temperatures and media.

Standard materials:
ECOPUR, SKF ECORUBBER/SKF ECOTAL, Aluminium.

Shaft diameter	Housing groove diameter		Housing groove length		Cross section
	D	D_1	L	L_1	
d over	incl.				c/s
mm	–	mm	–	mm	– mm
6	59,9	d+12	–	7	– 6
60	139,9	d+15	–	8	– 7,5
140	299,9	d+20	–	10	– 10
300	499,9	d+30	–	12	– 15
500	800	d+40	–	20	– 20
>800	>800	d+50	–	22	– 25

R09

Main function:
Double-acting rotary seal, O-ring activated PTFE seal.

Main applications:
Rotary pivots.

Advantages:
For high pressure.

Standard materials:
Ecoflon + NBR or Viton.

Shaft diameter	Housing groove diameter		Housing groove length		Cross section
	D	D_1	L	L_1	
d over	incl.				c/s
mm	–	mm	–	mm	– mm
6	18,9	d+4,9	–	2,2	– 2,45
19	37,9	d+7,5	–	3,2	– 3,75
38	199,9	d+11	–	4,2	– 5,5
200	255,9	d+15,5	–	6,3	– 7,75
256	649,9	d+21	–	8,1	– 10,5
>650	>650	d+28	–	9,5	– 14

R19

Main function:
Single-acting rotary seal, spring activated PTFE seal.

Main applications:
Bearing protection for chemical and pharma industries.

Advantages:
Low friction, good chemical and thermal resistance, suitable for high speed.

Standard materials:
Ecoflon, stainless steel spring.

Shaft diameter	Housing groove diameter		Housing groove length		Cross section
	D	D_1	L	L_1	
d over	incl.				c/s
mm	–	mm	–	mm	– mm
5	19,9	d+9	d+5	3,6	0,85 –
20	39,9	d+12,5	d+7	4,8	1,35 –
40	399,9	d+17,5	d+10,5	7,1	1,8 –
≥ 400	≥ 400	d+22	d+14	9,5	2,8 –

O-ring housing details and recommendations

Guide ring housing details and recommendations

Table 5

O-ring housing recommendations for static applications

Cord	Groove	Without back-up ring	One back-up ring	Two back-up rings	Recommended back-up ring width
d	t ± 0,05	b + 0,25	b ₁ + 0,25	b ₂ + 0,25	
mm	mm	mm	mm	mm	mm
1,5	1,10	2,1	3,1	4,1	1,0
1,78	1,35	2,5	3,5	4,5	1,0
2,00	1,56	2,7	4,2	5,7	1,5
2,50	2,05	3,3	4,8	6,3	1,5
2,62	2,18	3,5	5,0	6,5	1,5
3,00	2,52	3,9	5,4	6,9	1,5
3,50	3,00	4,4	5,9	7,4	1,5
3,53	3,00	4,4	5,9	7,4	1,5
4,00	3,40	5,0	6,7	8,4	1,7
5,00	4,25	6,3	8,0	9,7	1,7
5,33	4,53	6,7	8,4	10,1	1,7
5,70	4,85	7,1	9,1	11,1	2,0
6,00	5,10	7,5	9,5	11,5	2,0
6,99	5,94	8,8	10,8	12,8	2,0
7,00	5,95	8,8	10,8	12,8	2,0
8,00	6,80	10,0	12,5	15,0	2,5
10,00	8,50	12,5	15,0	17,5	2,5

Guide ring housing details and recommendations for dynamic applications. Our standard guide rings are available as 45° splitted versions. Those can be ordered as well as endless, 90° splitted versions or yard ware.

Table 1

Seal housing tolerances

- ØD H8
- Ød f8
- L +0,2



F01

Main function:
Rod guide rings

Rod diameter	Housing groove diameter	Housing groove length	Cross section
d over	incl.	D	L
mm	-	mm	mm
6	29,9	d+3	4
30	49,9	d+3	5,6
50	99,9	d+5	9,7
100	799,9	d+5	15
800	1 000	d+8	25
>1 000	>1 000	d+8	25

F01

Main function:
Piston guide rings

Bore diameter	Housing groove diameter	Housing groove length	Cross section
D over	incl.	d	L
mm	-	mm	mm
6	29,9	D-3	4
30	49,9	D-3	5,6
50	99,9	D-5	9,7
100	799,9	D-5	15
800	1 000	D-8	25
>1 000	>1 000	D-8	25

SKF – the knowledge engineering company

From the company that invented the self-aligning ball bearing more than 100 years ago, SKF has evolved into a knowledge engineering company that is able to draw on five technology platforms to create unique solutions for its customers. These platforms include bearings, bearing units and seals, of course, but extend to other areas including: lubricants and lubrication systems, critical for long bearing life in many applications; mechatronics that combine mechanical and electronics knowledge into systems for more effective linear motion and sensorized solutions; and a full range of services, from design and logistics support to conditioning monitoring and reliability systems.

Though the scope has broadened, SKF continues to maintain the world's leadership in the design, manufacture and marketing of rolling bearings, as well as complementary products such as radial seals. SKF also holds an increasingly important position in the market for linear motion products, high-precision aerospace bearings, machine tool spindles and plant maintenance services.

The SKF Group is globally certified to ISO 14001, the international standard for environmental management, as well as OHSAS 18001, the health and safety management standard. Individual divisions have been approved for quality certification in accordance with either ISO 9001 or ISO/TS 16949.

With some 100 manufacturing sites worldwide and sales companies in 70 countries, SKF is a truly international corporation. In addition, our distributors and dealers in some 15 000 locations around the world, an e-business marketplace and a global distribution system put SKF close to customers for the supply of both products and services. In essence, SKF solutions are available wherever and whenever customers need them. Overall, the SKF brand and the corporation are stronger than ever. As the knowledge engineering company, we stand ready to serve you with world-class product competencies, intellectual resources, and the vision to help you succeed.



Evolving by-wire technology

SKF has a unique expertise in fast-growing by-wire technology, from fly-by-wire, to drive-by-wire, to work-by-wire. SKF pioneered practical fly-by-wire technology and is a close working partner with all aerospace industry leaders. As an example, virtually all aircraft of the Airbus design use SKF by-wire systems for cockpit flight control.

SKF is also a leader in automotive by-wire technology, and has partnered with automotive engineers to develop two concept cars, which employ SKF mechatronics for steering and braking. Further by-wire development has led SKF to produce an all-electric forklift truck, which uses mechatronics rather than hydraulics for all controls.



Harnessing wind power

The growing industry of wind-generated electric power provides a source of clean, green electricity. SKF is working closely with global industry leaders to develop efficient and trouble-free turbines, providing a wide range of large, highly specialized bearings and condition monitoring systems to extend equipment life of wind farms located in even the most remote and inhospitable environments.



Working in extreme environments

In frigid winters, especially in northern countries, extreme sub-zero temperatures can cause bearings in railway axleboxes to seize due to lubrication starvation. SKF created a new family of synthetic lubricants formulated to retain their lubrication viscosity even at these extreme temperatures. SKF knowledge enables manufacturers and end user customers to overcome the performance issues resulting from extreme temperatures, whether hot or cold. For example, SKF products are at work in diverse environments such as baking ovens and instant freezing in food processing plants.



Developing a cleaner cleaner

The electric motor and its bearings are the heart of many household appliances. SKF works closely with appliance manufacturers to improve their products' performance, cut costs, reduce weight, and reduce energy consumption. A recent example of this cooperation is a new generation of vacuum cleaners with substantially more suction. SKF knowledge in the area of small bearing technology is also applied to manufacturers of power tools and office equipment.



Maintaining a 350 km/h R&D lab

In addition to SKF's renowned research and development facilities in Europe and the United States, Formula One car racing provides a unique environment for SKF to push the limits of bearing technology. For over 50 years, SKF products, engineering and knowledge have helped make Scuderia Ferrari a formidable force in F1 racing. (The average racing Ferrari utilizes more than 150 SKF components.) Lessons learned here are applied to the products we provide to auto-makers and the aftermarket worldwide.



Delivering Asset Efficiency Optimization

Through SKF Reliability Systems, SKF provides a comprehensive range of asset efficiency products and services, from condition monitoring hardware and software to maintenance strategies, engineering assistance and machine reliability programmes. To optimize efficiency and boost productivity, some industrial facilities opt for an Integrated Maintenance Solution, in which SKF delivers all services under one fixed-fee, performance-based contract.



Planning for sustainable growth

By their very nature, bearings make a positive contribution to the natural environment, enabling machinery to operate more efficiently, consume less power, and require less lubrication. By raising the performance bar for our own products, SKF is enabling a new generation of high-efficiency products and equipment. With an eye to the future and the world we will leave to our children, the SKF Group policy on environment, health and safety, as well as the manufacturing techniques, are planned and implemented to help protect and preserve the earth's limited natural resources. We remain committed to sustainable, environmentally responsible growth.

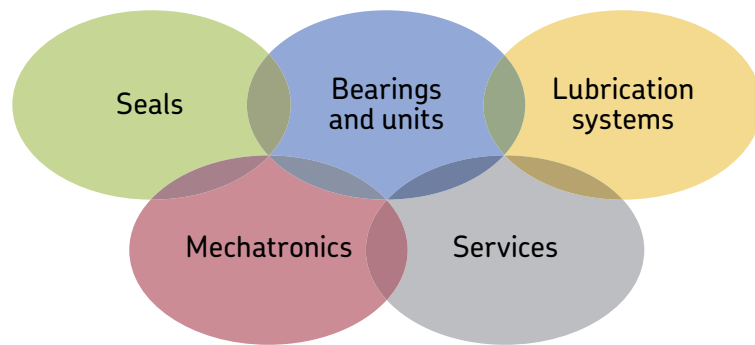



© SKF, ECONOMOS and ECOPUR are registered trademarks of the SKF Group.

© VITON is a registered trademark of DuPont.

© SKF Group 2008

The contents of this publication are the copyright of the publisher and may not be reproduced (even extracts) unless permission is granted. Every care has been taken to ensure the accuracy of the information contained in this publication but no liability can be accepted for any loss or damage whether direct, indirect or consequential arising out of the use of the information contained herein.

The data in this publication may differ from that shown in earlier publications because of redesign, technological developments or revised methods of calculation. SKF reserves the right to make continuing improvements to SKF products without prior notice with respect to materials, design and manufacturing methods, as well as changes necessitated by technological developments.

Publication 6567 EN · June 2008

This publication supersedes publication 44001098

Printed in Austria on environmentally friendly paper.